

Printmount Switch Short Stroke 12.7 mm



Printmount Switches
red

See below:

Approvals and Compliances

Description

- Switches are possible with different heights
- High-quality gold and silver contacts
- Solder terminals

Unique Selling Proposition

- Reliable tactile feedback on input
- Simple assembly
- Long life time

Weblinks

[pdf data sheet](#), [html datasheet](#), [General Product Information](#), [CAD-Drawings](#), [Product News](#), [Detailed request for product](#)

Technical Data

Electrical Data

Contact Material Silver

| | |
|--------------------------|--|
| Switching Voltage | max. 48 VDC |
| Switching current | max. 125 mA |
| Rated Switching Capacity | 2.4 W |
| Lifetime | > 1 million actuations at Rated Switching Capacity |
| Contact Resistance | < 50 mΩ < 50 mΩ after lifetime |
| Insulation Resistance | > 100 MΩ |
| Duration of Bounce | typ. 0.1 ms |

Contact Material Gold

| | |
|--------------------------|--|
| Switching Voltage | max. 24 VDC |
| Switching current | max. 50 mA |
| Rated Switching Capacity | 0.48 W |
| Lifetime | > 1 million actuations at Rated Switching Capacity |
| Contact Resistance | < 50 mΩ < 50 mΩ after lifetime |
| Insulation Resistance | > 100 MΩ |
| Duration of Bounce | typ. 0.1 ms |

Mechanical Data

| | |
|-------------------|------------------------|
| Actuating Force | 2.5 ± 0.5 N |
| Actuating Travel | 0.45 ± 0.1 mm |
| End Stop Strength | > 50 N |
| Lifetime | > 1 million actuations |

Climatical Data

| | |
|-----------------------|-----------------|
| Operating Temperature | -25 °C to 85 °C |
| Storage Temperature | -25 °C to 85 °C |
| IP-Protection | IP40 |

Other Data

| | |
|------------------|---------|
| Contact Material | Ag / Au |
|------------------|---------|

Soldering Data

| | |
|------------------------------|---|
| Solderability | 235 °C / 2 sec (IEC 60068-2-20 Test Ta Method 1) |
| Resistance to Soldering Heat | 260 °C / 5 sec (IEC 60068-2-20 Test Tb Method 1A) |

Material

| | |
|-------------------------|-----------------------------|
| Sealing membrane IP67 | VMQ |
| Contact Material Gold | CuZn37 3µm Ni 2 µm Au |
| Contact Material Silver | CuZn37 2,5 µm Au passivated |
| Socket | Thermoplastic (PA 66) |
| Actuator | Thermoplastic (PC) |
| Elongated Button | Thermoplastic (PC) |

Approvals and Compliances

Detailed information on product approvals, code requirements, usage instructions and detailed test conditions can be looked up in [Details about Approvals](#)

SCHURTER products are designed for use in industrial environments. They have approvals from independent testing bodies according to national and international standards. Products with specific characteristics and requirements such as required in the automotive sector according to IATF 16949, medical technology according to ISO 13485 or in the aerospace industry can be offered exclusively with customer-specific, individual agreements by SCHURTER.



Application standards

Application standards where the product can be used

| Organization | Design | Standard | Description |
|--------------|--------------------------------|----------------|---|
| | Suitable for applications acc. | IEC/UL 62368-1 | Audio/video, information and communication technology equipment - Part 1: Safety requirements |

Compliances

The product complies with following Guide Lines

| Identification | Details | Initiator | Description |
|--|------------|-------------|---|
|  | RoHS | SCHURTER AG | Directive RoHS 2011/65/EU, Amendment (EU) 2015/863 |
|  | China RoHS | SCHURTER AG | The law SJ / T 11363-2006 (China RoHS) has been in force since 1 March 2007. It is similar to the EU directive RoHS. |
|  | REACH | SCHURTER AG | On 1 June 2007, Regulation (EC) No 1907/2006 on the Registration, Evaluation, Authorization and Restriction of Chemicals 1 (abbreviated as "REACH") entered into force. |

Dimension [mm]

Short actuator

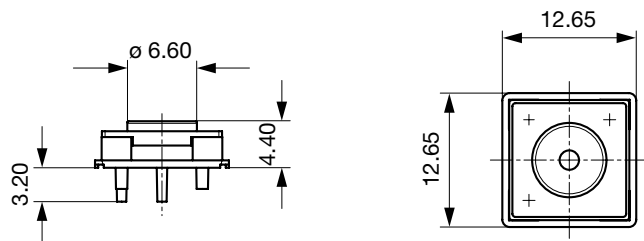

Long actuator

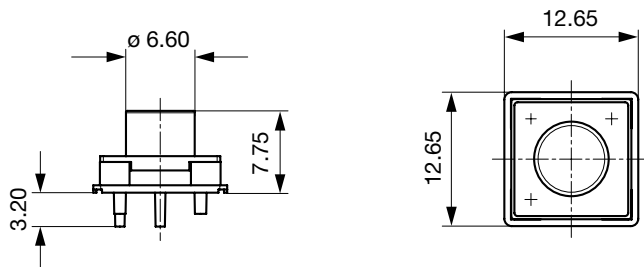

Height variable actuator

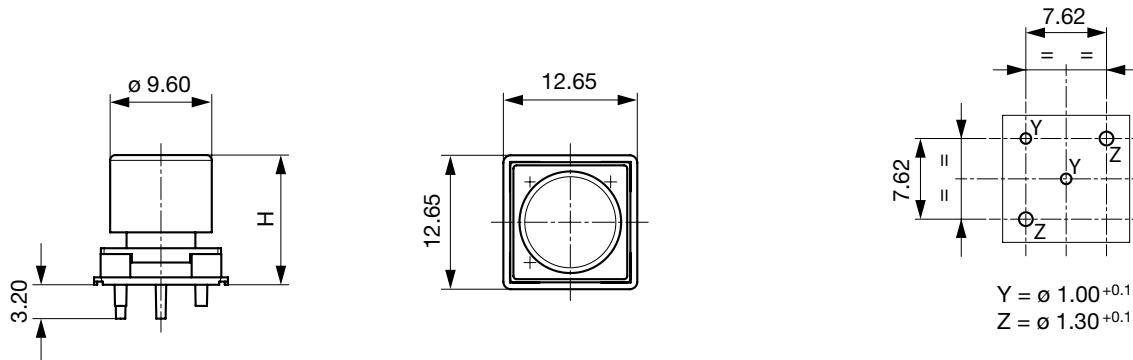

Drilling diagram

Diagrams

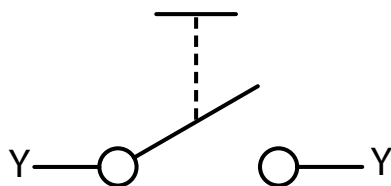

Order number key

| | | | | | | | | | | | | | | |
|---|---|---|---|-----|---|-----|---|----|---|---|---|---|---|---|
| M | T | G | - | H25 | - | D11 | - | AG | - | T | - | 1 | - | 0 |
| | | | 1 | | | 2 | | | 3 | | | 4 | | |
| | | | 1 | | | 2 | | | 3 | | | 4 | | |

Type  **1**

MTG = MTG

Switch height  **2**

4.0 mm = H03
 4.4 mm = H05
 5.9 mm = H09
 7.75 mm = H15
 7.8 mm = H16
 8.5 mm = H19
 9.25 mm = H21
 9.4 mm = H22
 10.0 mm = H25
 10.75 mm = H27
 11.5 mm = H29
 12.25 mm = H31
 13.0 mm = H35
 13.75 mm = H37
 13.85 mm = H38
 14.5 mm = H40
 15.25 mm = H42
 15.5 mm = H43
 16.0 mm = H45
 16.75 mm = H47
 17.5 mm = H49
 18.25 mm = H51
 19.0 mm = H53
 19.5 mm = H54
 19.75 mm = H56

Actuator diameter  **3**

6.0 mm = D08
 6.6 mm = D10
 9.6 mm = D11
 12.5 mm = D12
 12.6 mm = D13

Contact material  **4**

Silver = AG
 Gold = AU

Soldering type  **5**

THT = T

Rated current  **6**

50 mA = 1
 125 mA = 3

Customer specific type  **7**

Standard = 0
 Customized = C

Variants

| Kontakte | Type | Overall height / Color | Overall height ¹⁾ / Color | Bestellnummer |
|----------|-----------------|------------------------|--------------------------------------|---------------|
| Au | Long actuator | - | - | 1241.1022 |
| Au | Height variable | 10.75 mm / blue | - | 1241.1032.4 |
| Ag | Short actuator | - | - | 1241.1052 |
| Ag | Long actuator | - | - | 1241.1072 |
| Ag | Height variable | 8.50 mm / yellow | - | 1241.1082.1 |
| Ag | Height variable | - | 14.50 mm / yellow + black | 1241.1082.11 |
| Ag | Height variable | 9.25 mm / orange | - | 1241.1082.2 |
| Ag | Height variable | 10.00 mm / red | - | 1241.1082.3 |
| Ag | Height variable | 10.75 mm / blue | - | 1241.1082.4 |
| Ag | Height variable | - | 16.75 mm / blue + black | 1241.1082.41 |
| Ag | Height variable | 11.50 mm / green | - | 1241.1082.5 |
| Ag | Height variable | 13.75 mm / white | - | 1241.1082.8 |

¹⁾ Starting with 14.50 mm the heights are achieved with an additional (second) cap of black color

Availability for all products can be searched real-time: <https://www.schurter.com/en/info-center/support-tools/stock-check-distributors>

Packaging unit 100 pcs