

**特点 Features:**

- 触点容量:8A触点切换能力  
Switching capability:8A.
- 两组转换触点形式  
2 transfer contact configuration.
- 高耐压 5KV  
Dielectric Strength:5KV(between coil&contacts)

**触点参数 CONTACT DATA**

型号	Model	YX208T
触点形式	Contact Arrangement	2A、2B、2C
接触电阻	Contact Resistance	100mΩ Max.
触点材料	Contact Material	银合金 Silver Alloy
额定负载(阻性)	Contact Rating ( Res.Load )	8A 250VAC/30VDC
最大切换电流	Max. Switching Current	8A
最大切换电压	Max. Switching Voltage	250VAC/30VDC
最大切换功率	Max. Switching Power	2000VA/240W
机械寿命	Mechanical endurance	1x10 <sup>7</sup> 次 OPS
电气寿命	Electrical endurance	1x10 <sup>5</sup> 次 OPS

**性能参数 CHARACTERISTICS**

吸合时间(额定电压下)	Operate Time ( at nomi.volt. )	15ms Max.
释放时间(不带二极管)	Release Time ( without diode )	8ms Max.
绝缘电阻	Insulation Resistance	1000MΩ Min.( 500VDC )
介质耐压	Dielectric Strength	触点与触点间 Between Open Contacts : 1000VAC, 50/60Hz 1 min.
		触点与线圈间 Between Coil & Contacts : 5000VAC, 50/60Hz 1 min
		触点组与组之间 Between Contact sets : 1500VAC, 50/60Hz 1 min
抗振性	Vibration resistance	误动作 Functional: 10~50Hz 双振幅 1.5mm ( DA )
		耐久 Destructive: 10~50Hz 双振幅 1.5mm ( DA )
抗冲击	Shock resistance	误动作 Functional: 10G Min.
		耐久 Destructive: 100G Min.
环境温度	Ambient Temperature	-40°C~+85°C (不冷凝 No condensation)
重量	Unit Weight	约 Approx. 14.5g

**线圈参数 COIL DATA (at 23°C)**

额定电压 Rated voltage (VDC)	额定电流 Rated current ±10%(mA)	线圈电阻 Coil resistance ±10%(Ω)	最大连续外加电压 Max allowable voltage VDC (Max.)	吸合电压 Operate voltage VDC (Max.)	释放电压 Release voltage VDC (Min.)	额定功率 Rated coil power (W)
5	108.0	46	额定电压的 of rated voltage 130 %	额定电压的 of rated voltage 75 %	额定电压的 of rated voltage 5 %	约approx 0.54
6	90.0	67				
9	60.0	150				
12	45.0	270				
18	30.0	600				
24	22.5	1,067				
48	11.3	4,267	额定电压的 of rated voltage 130 %	额定电压的 of rated voltage 75 %	额定电压的 of rated voltage 5 %	约approx 0.72
5	144.0	35				
6	120.0	50				
9	80.0	113				
12	60.0	200				
18	40.0	450				
24	30.0	800				
48	15.0	3,200				

## 订货标记示例 ORDERING INFORMATION

YX208T	-S	-2	12	D	M	
		触点形式 Contact form :		无-转换, M-常开, B-常闭 Nil-Form C, M-Form A, B-Form B		
		线圈功耗 Coil power :		D-0.54W (0.72W 可选 optional)		
		线圈规格 Coil voltage :		05,06,09,12,18,24,48 (VDC)		
		触点组数 Number of poles :		2-2组 2-2 Group		
		封装形式 Protective construction :		S-塑封式 S-Flux proofed		
		基本型号 Type designation :		YX208T		

## 外形尺寸、接线图、安装孔位图 (单位: mm)

## OUTLINE DIMENSIONS, WIRING DIAGRAM AND PCB LAYOUT (Unit: mm)

外形尺寸  
Outline Dimensions

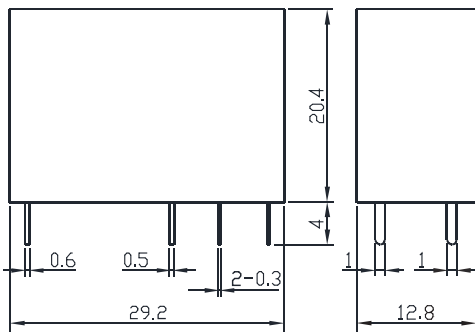

安装孔位图 (底视图)  
PCB Layout (Bottom View)

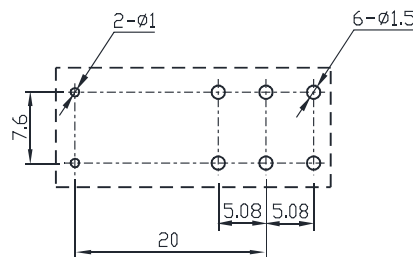

接线图 (底视图)  
Wiring Diagram (Bottom View)

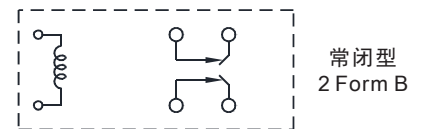
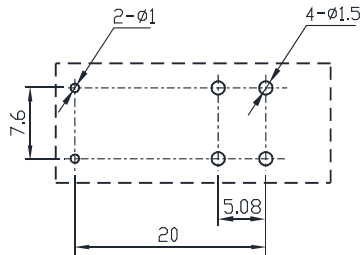
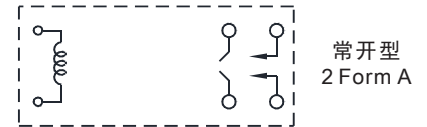
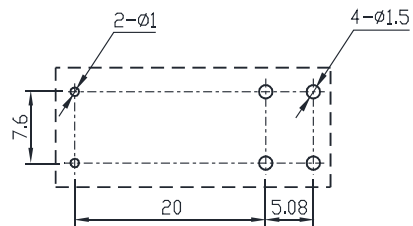
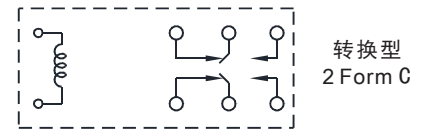

注 Remark :

- 未标注尺寸公差  
Unmarked dimensional tolerance  
  - ≤1mm: ±0.2mm ;
  - (1~5)mm: ±0.3mm ;
  - ≥5mm: ±0.4mm.
- 安装孔尺寸公差: ±0.1mm.  
The tolerance of PCB layout is always: ±0.1mm.
- 引出脚尺寸为预焊前尺寸。  
Extended terminal dimension is dimension before soldering.

## 性能曲线图 CHARACTERISTIC CURVES

最大切换功率  
Max. Switching Power

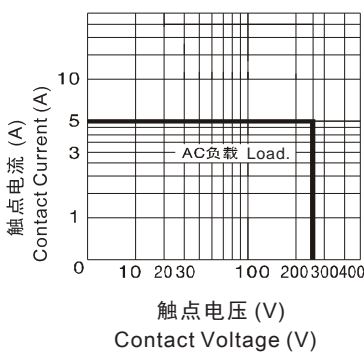

寿命曲线  
Endurance Curve

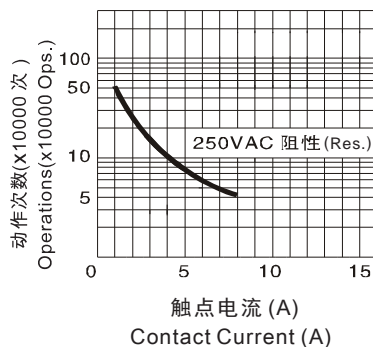

线圈温升  
Coil Temperature Rise

