

HF115F

MINIATURE HIGH POWER RELAY



File No.:E134517



File No.:116934



File No.:CQC08002028130



Features

- Low height: 15.7 mm
- 16A switching capability
- 5kV dielectric strength (between coil and contacts)
- Contact gap: $\geq 0.75\text{mm}$, with optional specifications
- Creepage distance: 10mm
- Meeting VDE 0700, 0631 reinforce insulation
- Product in accordance to IEC 60335-1 available
- Sockets available
- Plastic sealed and flux proofed types available
- UL insulation system: Class F available

RoHS compliant

CONTACT DATA

Contact arrangement	1A, 1B, 1C	2A, 2B, 2C
Contact resistance ¹⁾	100m Ω max.(at 1A 6VDC)	
Contact material	See ordering info.	
Contact rating (Res. load)	12A/16A 250VAC	8A 250VAC
Max. switching voltage ²⁾	440VAC / 300VDC	
Max. switching current	12A / 16A	8A
Max. switching power	3000VA / 4000VA	2000VA
Mechanical endurance	1 x 10 ⁷ OPS	
Electrical endurance	1H3B type: 1 x 10 ⁵ OPS (16A 250VAC, Resistive load, Room temp., 1s on 9s off) 2H4B type: 5 x 10 ⁴ OPS (8A 250VAC, Resistive load, Room temp., 1s on 9s off)	

Notes: 1) The data shown above are initial values,
2) see maximum switching power curve.

CHARACTERISTICS

Insulation resistance	1000M Ω (at 500VDC)	
Dielectric strength	Between coil & contacts	5000VAC 1min
	Between open contacts	1000VAC 1min
	Between contact sets	2500VAC 1min
Surge voltage (between coil & contacts)	10kV (1.2 / 50 μ s)	
Operate time (at nomi. volt.)	15ms max.	
Release time (at nomi. volt.)	8ms max.	
Temperature rise (at nomi. volt.)	55K max.	
Shock resistance *	Functional	98m/s ²
	Destructive	980m/s ²
Vibration resistance *	10Hz to 150Hz 10g/5g	
Humidity	5% to 85% RH	
Ambient temperature	-40°C to 85°C	
Termination	PCB	
Unit weight	Approx. 13.5g	
Construction	Plastic sealed, Flux proofed	

Notes: 1) The data shown above are initial values.
2) * Index is not in relay length direction.
3) UL insulation system: Class F, Class B.



HONGFA RELAY

ISO9001, IATF16949, ISO14001, ISO45001, IECQ QC 080000, ISO/IEC 27001 CERTIFIED

2025 Rev. 1.00

COIL

Coil power	Approx. 400mW
------------	---------------

COIL DATA

at 23°C

Nominal Voltage VDC	Pick-up Voltage VDC max.1)	Drop-out Voltage VDC min.1)	Max. Voltage VDC 2)	Coil Resistance Ω
5	3.50	0.5	7.5	62 x (1 \pm 10%)
6	4.20	0.6	9.0	90 x (1 \pm 10%)
9	6.30	0.9	13.5	202 x (1 \pm 10%)
12	8.40	1.2	18	360 x (1 \pm 10%)
18	12.60	1.8	27	810 x (1 \pm 10%)
24	16.80	2.4	36	1440 x (1 \pm 10%)
48 ³⁾	33.60	4.8	72	5760 x (1 \pm 15%)
60 ³⁾	42.00	6.0	90	7500 x (1 \pm 15%)
110 ³⁾	77.00	11.0	165	25200 x (1 \pm 15%)

Notes: 1) The data shown above are initial values.

2) Maximum voltage refers to the maximum voltage which relay coil could endure in a short period of time.

3) For products with rated voltage $\geq 48\text{V}$, measures should be taken to prevent coil overvoltage in order to protect coil in test and application (eg. Connect diodes in parallel).

SAFETY APPROVAL RATINGS

VDE

Contact material	Specifications	Ratings	Ambient Temperature
AgCdO	HF115F....2(H;Z)(S)4(G)(F)	8A 250VAC	70°C
	HF115F....1H(S)(1;2)(G)(F)	12A 250VAC	70°C
		10A 250VAC	70°C
	HF115F....1Z(S)(1;2)(G)(F)	12A 250VAC	70°C
	HF115F....1H(S)3(G)(F)	16A 250VAC	70°C
		10A 250VAC	70°C
		9A 250VAC COS ϕ =0.4	70°C
	HF115F....1Z(S)3(G)(F)	16A 250VAC	70°C
9A 250VAC COS ϕ =0.4	70°C		
AgNi	HF115F....2(H;Z)(S)4B(G)(F)	5A 400VAC	85°C
		8A 250VAC	85°C
	HF115F....1H(S)(1;2)B(G)(F)	12A 250VAC	85°C
	HF115F....1Z(S)(1;2)B(G)(F)	12A 250VAC	85°C
	HF115F....1H(S)3B(G)(F)	16A 250VAC	85°C
		9A 250VAC COS ϕ =0.4	70°C
	HF115F....1Z(S)3B(G)(F)	16A 250VAC (NO only)	85°C
		12A 250VAC	85°C
		9A 250VAC COS ϕ =0.4 (NO only)	70°C
		10(4)A 250VAC (NO only)	65°C
12(2)A 250VAC (NO only)	65°C		
AgSnO ₂	HF115F....2(H;Z)(S)4A(G)(F)	8A 250VAC	85°C
	HF115F....1(H;Z)(S)(1;2)A(G)(F)	12A 250VAC	85°C
	HF115F....1H(S)3A(G)(F)	16A 250VAC	85°C
		9A 250VAC COS ϕ =0.4	70°C
	HF115F....1Z(S)3A(G)(F)	16A 250VAC (NO only)	85°C
		9A 250VAC COS ϕ =0.4 (NO only)	70°C

UL/CUL

Version 1 or 2 (AgCdO)	12A 277VAC	Version 3 (AgSnO ₂)	16A 277 VAC
	1/2HP 250VAC		1/3HP 125VAC
	1/3HP 125VAC		1/2HP 250VAC
Version 1 or 2 (AgSnO ₂)	12A/ 277VAC	Version 4 (AgCdO)	B300
	B300		R300
	R300		10A 250VAC
Version 1 or 2 (AgNi)	12A 277VAC	Version 4 (AgSnO ₂)	8A 277VAC
	16A 277 VAC		1/2HP 250VAC
	9A 250VAC 105°C		1/4HP 125VAC
Version 3 (AgCdO)	1HP 250VAC	Version 4 (AgNi)	8A 277VAC
	1/2HP 125VAC		10A 250VAC
	TV-5 125VAC		1/2HP 250VAC
	16A 277VAC		1/4HF 250VAC
Version 3 (AgNi)	5FLA, 30LRA 250VAC	8A 277VAC	
		10A 250VAC	

Notes: 1) All values unspecified are at room temperature.

2) Only typical loads are listed above. Other load specifications can be available upon request.

ORDERING INFORMATION

Type	HF115F / 012 -1H S 1 A F (XXX)					
Coil voltage	5, 6, 9, 12, 18, 24, 48, 60, 110VDC					
Contact arrangement	1H: 1 Form A 2H: 2 Form A		1D: 1 Form B 2D: 2 Form B		1Z: 1 Form C 2Z: 2 Form C	
Construction ¹⁾²⁾	S: Plastic sealed			Nil: Flux proofed		
Version	1: 3.5mm 1 pole 12A 3: 5.0mm 1 pole 16A		2: 5.0mm 1 pole 12A 4: 5.0mm 2 pole 8A			
Contact material ³⁾	A: AgSnO ₂ (Character (A) may follow the batch number) Nil: AgCdO G: AgCdO+ Au plated AG: AgSnO ₂ + Au plated			B: AgNi BG: AgNi+ Au plated		
Insulation standard	F: Class F		Nil: Class B			
Special code ⁴⁾	XXX: Customer special requirement			Nil: Standard		

- Notes:** 1) We recommend flux proofed types for a clean environment (free from contaminations like H₂S, SO₂, NO₂, dust, etc). We suggest to choose plastic sealed types and validate it in real application for an unclean environment (with contaminations like H₂S, SO₂, NO₂, dust, etc).
- 2) Contact is recommend for suitable condition and specifications if water cleaning or surface process is involved in assembling relays on PCB.
- 3) For gold plated type, the min. switching current and min. switching voltage is 10mA 5VDC.
- 4) The customer special requirement express as special code after evaluating by Hongfa, e.g. (335) stands for product in accordance to IEC 60335-1 (GWT); (253) stands for Reflow soldering version, for 1 pole type.(AL2)indicates that the contact gap of the product is ≥0.75mm, plastic sealed typ(Only for HF115F 2H).
- 5) Two packing methods available: plastic tray package, tube package,Standard tube packing length is 616mm. Any special requirement needed, please contact us for more details.
- 6) For products that should meet the explosion-proof requirements of "IEC 60079 series",please note [Ex] after the specification while placing orders.Not all products have explosion-proof certification,so please contact us if necessary, in order to select the suitable products.

OUTLINE DIMENSIONS, WIRING DIAGRAM AND PC BOARD LAYOUT

Unit: mm

Outline Dimensions

3.5mm Pinning (HF115F/□□□-1□-□-1-□□)

5mm Pinning (HF115F/□□□-□□-□-2/3/4-□□)

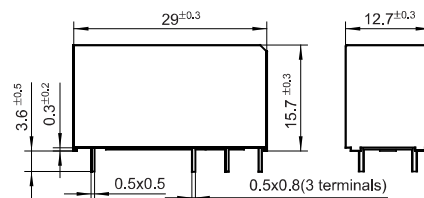
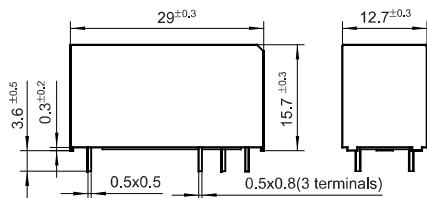

Wiring Diagram (Bottom view)

3.5/5mm Pinning, 1 Pole, 12A, HF115F/□□□-1□-□-1/2-□□



1 Form A



1 Form B



1 Form C

5mm Pinning, 1 Pole, 16A, HF115F/□□□-1□-□-3-□□



1 Form A

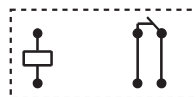

1 Form B

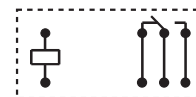

1 Form C

5mm Pinning, 2 Pole, 8A, HF115F/□□□-2□-□-4-□□

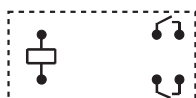

2 Form A

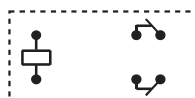

2 Form B

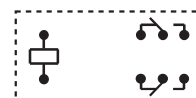

2 Form C

OUTLINE DIMENSIONS, WIRING DIAGRAM AND PC BOARD LAYOUT

Unit: mm

PCB Layout (Bottom view)

3.5 Pinning, 1 Pole, 12A, HF115F/□□□-1□-□-1□□

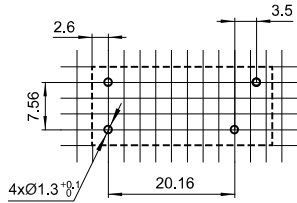

1 Form A

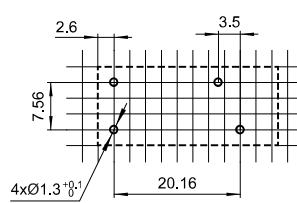

1 Form B

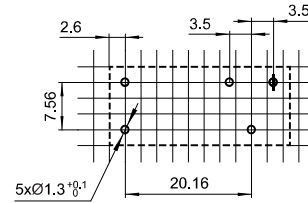

1 Form C

5mm Pinning, 1 Pole, 12A, HF115F/□□□-1□-□-2□□

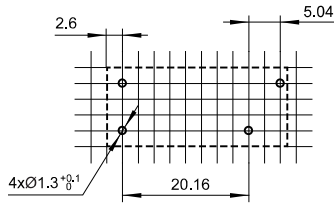

1 Form A

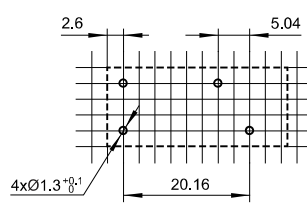

1 Form B

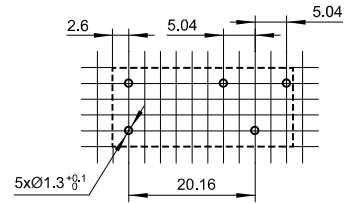

1 Form C

5mm Pinning, 1 Pole, 16A, HF115F/□□□-1□-□-3□□

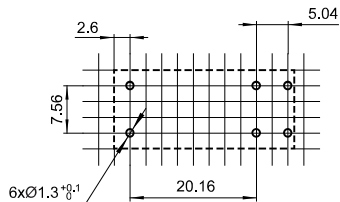

1 Form A

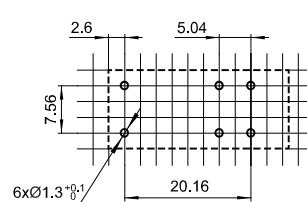

1 Form B

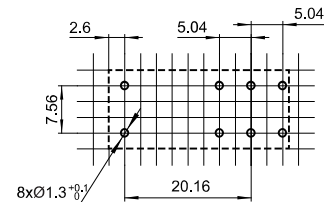

1 Form C

5mm Pinning, 2 Pole, 8A, HF115F/□□□-2□-□-4□□

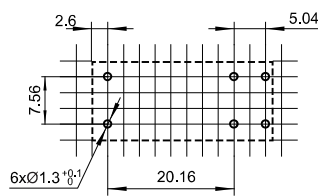

2 Form A

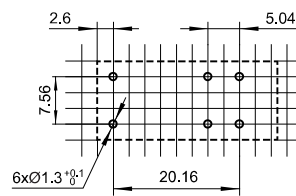

2 Form B

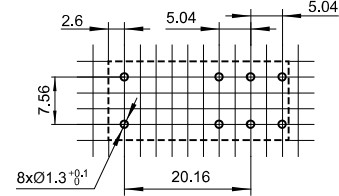

2 Form C

- Remark: 1) In case of no tolerance shown in outline dimension: outline dimension $\leq 1\text{mm}$, tolerance should be $\pm 0.2\text{mm}$; outline dimension $> 1\text{mm}$ and $\leq 5\text{mm}$, tolerance should be $\pm 0.3\text{mm}$; outline dimension $> 5\text{mm}$, tolerance should be $\pm 0.4\text{mm}$,
 2) The tolerance without indicating for PCB layout is always $\pm 0.1\text{mm}$.
 3) The width of the gridding is 2.52mm.

CHARACTERISTIC CURVES

MAXIMUM SWITCHING POWER

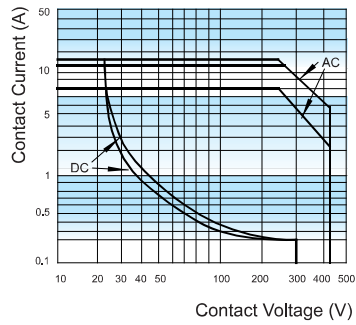

COIL OPERATING RANGE (DC) *

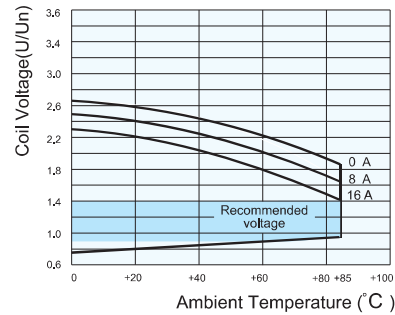

Notes: * The use of a relay with an energising voltage other than the rated coil voltage may lead to reduced electrical life. An energising voltage over the above range may damage the insulation of relay coil.

ENDURANCE CURVE(Inductive)

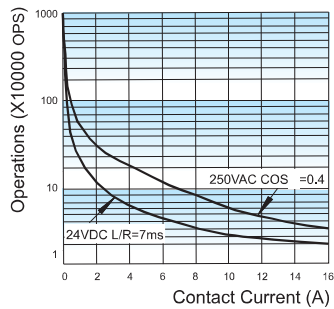

Remark:

- Curve: 1H3A type
- Test conditions:
NO, 85°C, 1s on 9s off, Flux proofed.

ENDURANCE CURVE(Resistive)

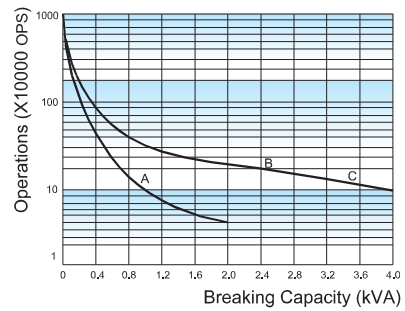

Remark:

- Curve A: 2H4B type
Curve B: 1H1B type(or 1H2B type)
Curve C: 1H3B type
- Test conditions:
NO, Resistive load, 250VAC,
Flux proofed, Room temp., 1s on 9s off.

Relay Sockets

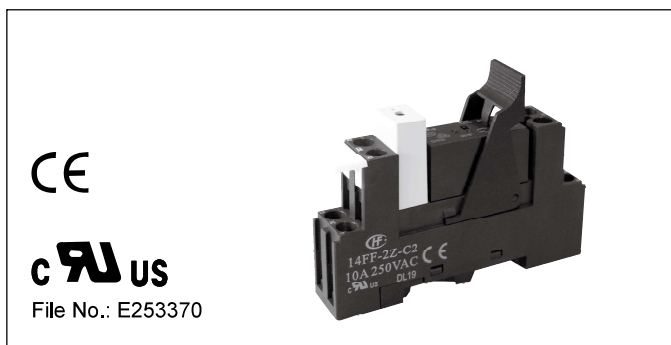

Features



- The insulation resistance is 1000MΩ
- Three mounting types are available: PCB, screw mounting and DIN rail mounting
- With finger protection device
- Many kinds of plug-in modules are available with the function of energizing indication and wiring protection
- Environmental friendly product (RoHS compliant)

CHARACTERISTICS

type	Nominal Voltage	Nominal Current	Ambient Temperature	Dielectric Strength min.	Screw Torque	Wire Strip Length	Unit weight
14FF-2Z-A1	250VAC	10A	-40°C ~ 70°C	5000VAC	—	*	Approx.3g
14FF-2Z-C2	250VAC	10A	-40°C ~ 70°C	5000VAC	0.6N·m	7mm	Approx.39g
14FF-2Z-C3	250VAC	10A	-40°C ~ 70°C	5000VAC	0.6N·m	7mm	Approx.45g
14FF-2Z-C4	250VAC	10A	-40°C ~ 70°C	5000VAC	—	9mm	Approx.42g
14FF-2Z-C10	300VAC/DC	10A	-40°C ~ 70°C	5000VAC	—	10mm	Approx.36g
14FF-2Z-C10/P	300VAC/DC	10A	-40°C ~ 70°C	5000VAC	—	10mm	Approx.37g

OUTLINE DIMENSIONS, WIRING DIAGRAM AND PC BOARD LAYOUT

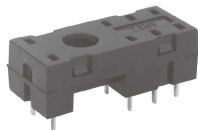
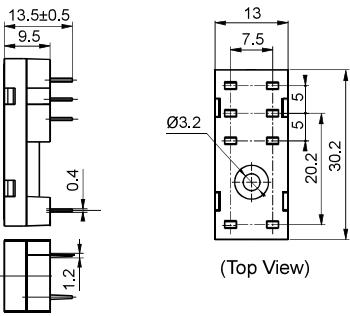
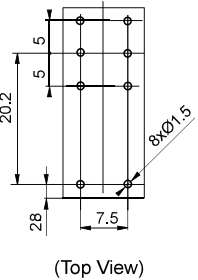

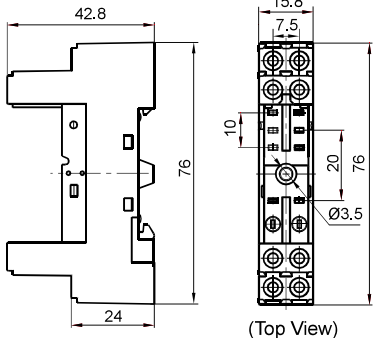
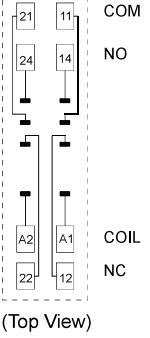



Unit: mm

Socket	Outline Dimensions	Wiring Diagram/PCB Layout	Components Available
<p>14FF-2Z-A1</p>  <p>PCB terminal, PCB or Screw mounting</p> <p>When it used with HF115F, HF115F-A, HF115FP and relay type 3, two pole of socket load must connect in parallel.</p>	 <p>(Top View)</p>	 <p>(Top View)</p>	<p>Metallic retainer 14FF-H1</p> <p>Remarks:the dielectric strength can reach 1500VAC that sockets mounted 14FF-H1</p>
<p>14FF-2Z-C2</p>  <p>Screw Terminal, DIN rail or Screw mounting, With finger protection device</p> <p>Applicable for HF115F/XXX-1XX3XXX HF115F/XXX-1XX4XXX</p> <p>When it is HF115F/XXX-1XX-3XXX, "21"- "11", "24"- "14", "22"- "12" of socket must connect in parallel.</p>	 <p>(Top View)</p>	 <p>(Top View)</p>	<p>Plastic retainer: 14FF-H4</p> <p>Marker: 14FF-M1</p> <p>Plug-in module: HFAA to HFHU*</p>

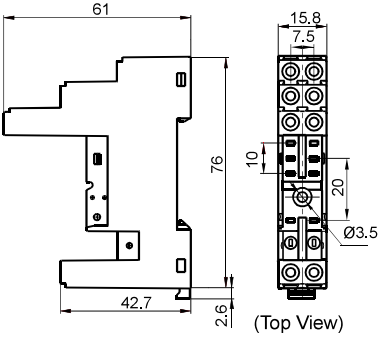
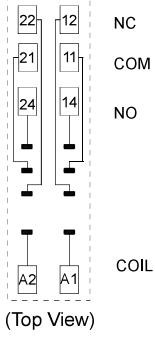
Notes: If need accessry,please order with type.

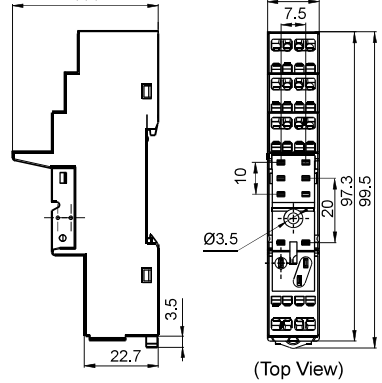
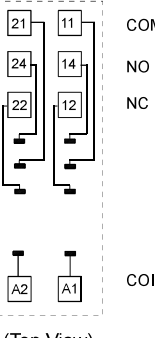
OUTLINE DIMENSIONS, WIRING DIAGRAM AND PC BOARD LAYOUT

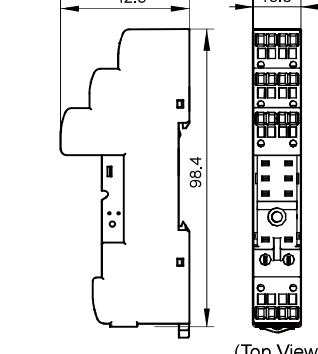
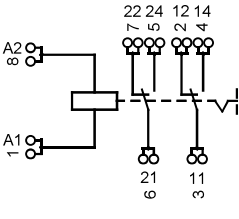
Unit: mm

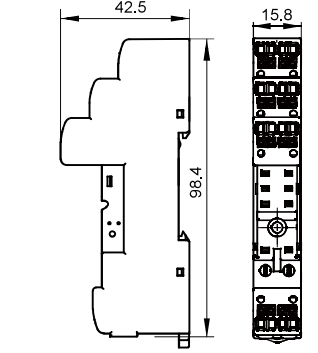
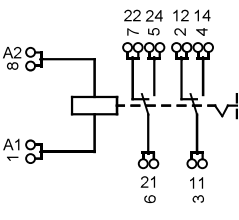
Socket	Outline Dimensions	Wiring Diagram	Components Available
<p>14FF-2Z-C3</p>  <p>Screw Terminal, DIN rail or Screw mounting, With finger protection device When it used with HF115F, HF115F-A, HF115FP and relay type 3, "21"-11", "24"-14", "22"-12" of socket must connect in parallel.</p>	 <p>(Top View)</p>	 <p>(Top View)</p>	<p>Retainer: 14FF-H4</p> <p>Marker: 14FF-M1</p> <p>Plug-in module: HFAA~HFHU*</p>
<p>14FF-2Z-C4</p>  <p>Spring-loaded terminal DIN rail mounting With finger protection device When it used with HF115F, HF115F-A, HF115FP and relay type 3, "21"-11", "24"-14", "22"-12" of socket must connect in parallel.</p>	 <p>(Top View)</p>	 <p>(Top View)</p>	<p>Retainer: 14FF-H4</p> <p>Marker: 14FF-M1</p> <p>Plug-in module: HFAA~HFHU*</p>
<p>14FF-2Z-C10</p> 	 <p>(Top View)</p>		<p>Retainer: 14FF-H4 14FF-H7</p> <p>Marker: 14FF-M1</p> <p>Plug-in module: HFAA~HFHU</p>
<p>14FF-2Z-C10/P</p> 	 <p>(Top View)</p>		<p>Retainer: 14FF-H4 14FF-H7</p> <p>Marker: 14FF-M1</p> <p>Plug-in module: HFAA~HFHU</p>

Notes: If need accessory, please order with type.

DIMENSION OF RELATED COMPONENT (AVAILABLE)

Unit: mm

Retainer

14FF-H1 (Metallic retainer)

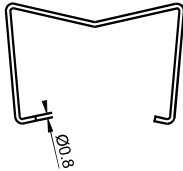

14FF-H4 (Plastic retainer)

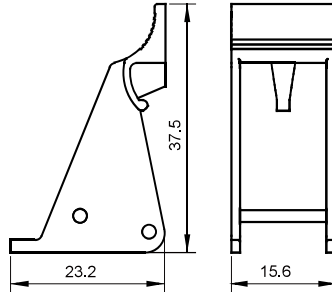

14FF-H7 (Metallic retainer)

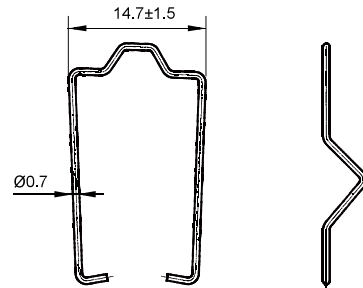

Marker

14FF-M1

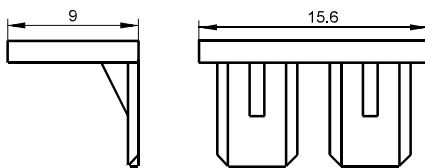

Precautions For Use

For your personal safety and the normal operation of the equipment, as well as to prevent fire, please note the following issues:

1. The rated current of the socket should be no less than the rated current of the relay.
2. Sockets are required to be firmly fixed to prevent the wiring from loosening and affecting the quality of wiring.
3. Be sure to disconnect power to the outlet before installation, disassembly, wiring, maintenance and inspection.
4. Prevent foreign objects such as wire shavings from falling inside this product when wiring.
5. Be sure to install the relay in place, and use accessories such as retainer if necessary to improve contact reliability. Do not use with incomplete connections.
6. Be sure to observe the relay ratings and do not overload the relay.
7. Before selecting a relay, make sure that the drive voltage matches the relay excitation voltage.

Applicable conductor cross section

solid wire	1×0.5/0.75/1.0/1.5/2.5 mm ²	
	2×0.5/0.75/1.0/1.5 mm ²	
Multi-stranded wire	Multi-stranded wire without standard sleeve	1×0.5/0.75/1.0/1.5/2.5 mm ²
		2×0.5/0.75/1.0/1.5 mm ²
	Multi-stranded wire with standard sleeve	1×0.5/0.75/1.0/1.5 mm ²
		2×0.5/0.75/1.0 mm ²

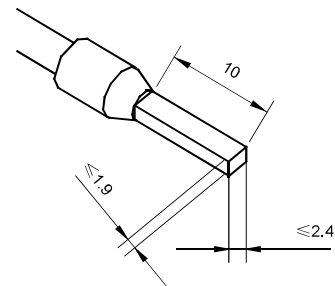

Precautions For Use

Regarding push in socket

- The screwdriver insertion hole must not be wired.
 - When inserting the screwdriver into the hole, please insert it at an angle.
 - Do not twist or wiggle the screwdriver when it is in the hole, as this may cause damage the socket.
 - Do not forcibly bend or pull on the wire. Otherwise it may result broken wire.
 - Do not insert more than one wires into one wiring hole.
 - To prevent smoke and fire from the wiring material, check the power supply rating and that the wire sleeves used are in accordance with DIN 46228-4.
- The conductors used comply with GB/T 5023.3-2008 (IEC 60227-3) standard.

Recommended Wires	Film peel (when bar terminals are not used)
0.5~2.5mm ² /AWG20~14	≥10mm

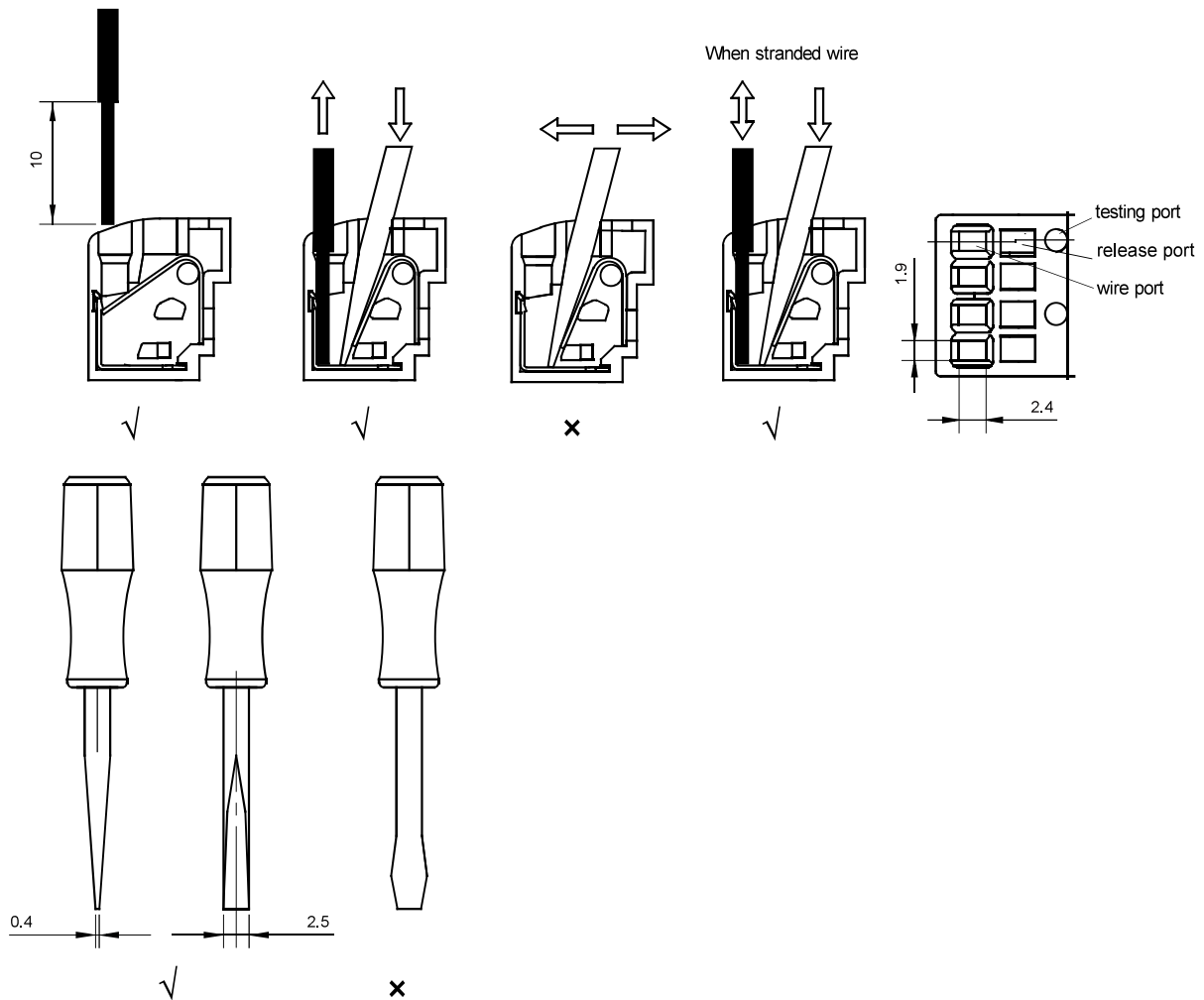

Things to be noticed when selecting sockets:

1. Please choose suitable relay socket according to the actual mounting environment, relay contact poles and terminal layout. If there is any query on selection, please contact Hongfa for the technical service;
2. Socket which can be mounted with markers is furnished with a marker; as for other related components, they should be selected separately. Please do give clear indication of the types of relay sockets and related components you choose while placing order.
3. The above is only an example of typical socket and related component type which is suitable to HF115FP relay. If you have any special requirements, please contact us.
4. Main outline dimension, outline dimension > 50mm, tolerance should be $\pm 1\text{mm}$; $20\text{mm} < \text{outline dimension} \leq 50\text{mm}$, tolerance should be $\pm 0.5\text{mm}$; $5\text{mm} < \text{outline dimension} \leq 20\text{mm}$, tolerance should be $\pm 0.4\text{mm}$; outline dimension $\leq 5\text{mm}$, tolerance should be $\pm 0.3\text{mm}$;
5. DIN rail mounting: recommend to use standard rail $35 \times 7.5 \times 1\text{mm}$, $35 \times 15 \times 1\text{mm}$. When installed vertically, the coil terminal at the bottom please .

Disclaimer

The specification is for reference only. See to "Terminology and Guidelines" for more information. Specifications subject to change without notice. We could not evaluate all the performance and all the parameters for every possible application. Thus the user should be in a right position to choose the suitable product for their own application. If there is any query, please contact Hongfa for the technical service. However, it is the user's responsibility to determine which product should be used only.

© Xiamen Hongfa Electroacoustic Co., Ltd. All rights of Hongfa are reserved.