



Film Capacitors

Metallized Polypropylene Film Capacitors (MKP)

Series/Type: B32651 ... B32658

Date: October 2024

High pulse (wound)
Applications

- Electronic ballasts
- Switch-mode power supplies
- IGBT
- Snubbing

Climatic

- Max. operating temperature: 110°C
- Climatic category (IEC 60068-1): 40/100/56

Construction

- Dielectric: polypropylene (MKP)
- Wound capacitor technology
- Plastic case (UL 94 V-0)
- Epoxy resin sealing (UL 94 V-0)

Features

- High pulse strength
- High contact reliability
- RoHS-compatible
- Very low inductance
- Halogen free capacitors available on request
- AEC-Q200 compliant

Terminals

- Parallel wire leads, lead-free tinned
- Special lead lengths available on request

Marking

Manufacturer's logo, lot number, series number (e.g. 651), rated capacitance (coded), capacitance tolerance (code letter), rated DC voltage (AC voltage for 1600 V / 700 V AC and 2000 V DC / 1000 V AC), date of manufacture (coded)

Delivery mode

- Bulk (untaped)
- Taped (Ammo pack or reel)
- For notes on taping, refer to chapter "Taping and packing"

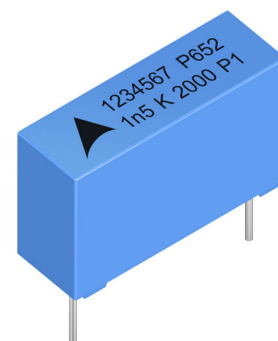

Dimensional drawings

Number of wires	Lead space $e \pm 0.4$	Lead diameter $d_1 \pm 0.05$	Type	Drawing
2-pin	10.0	0.6	B32651	A1
2-pin	15.0	0.8	B32652	A1
2-pin	22.5	0.8	B32653	A1
2-pin	27.5	0.8	B32654	A1
2-pin	37.5	1.0	B32656A/J	A1
2-pin	37.5	1.0	B32656T	A2
4-pin	37.5	1.2	B32656G	B1
4-pin	52.5	1.2	B32658G	B1

(Dimensions in mm)

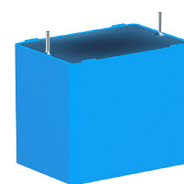
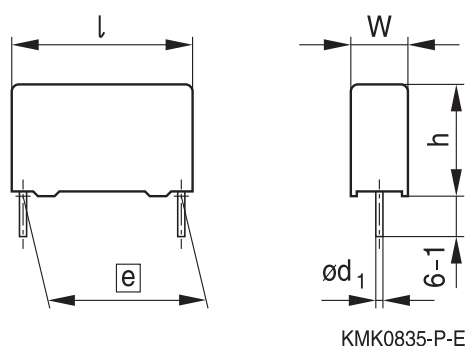
Dimensions drawing 2-pin versions
Drawing A1

	B32651	B32652	B32653	B32654	B32656A/J
Lead spacing $e \pm 0.4$	10.0	15.0	22.5	27.5	37.5
Lead diameter d_1 :	0.6	0.8	0.8	0.8	1.0

(Dimensions in mm)

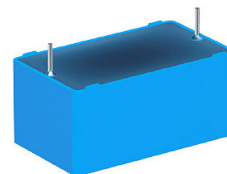
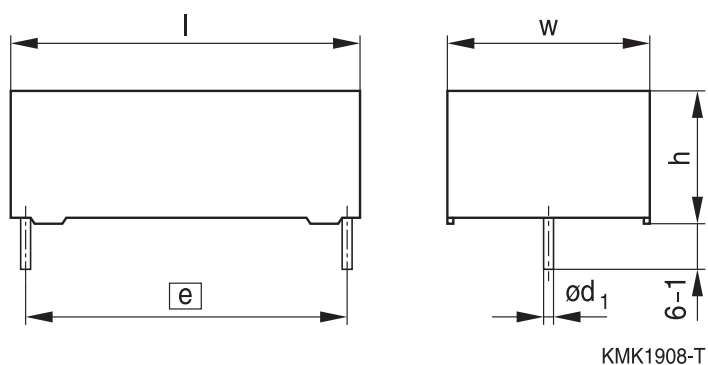
Drawing A2 (low profile)

	B32656T
Lead spacing $e \pm 0.4$	37.5
Lead diameter d_1 :	1.0

(Dimensions in mm)

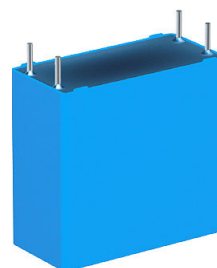
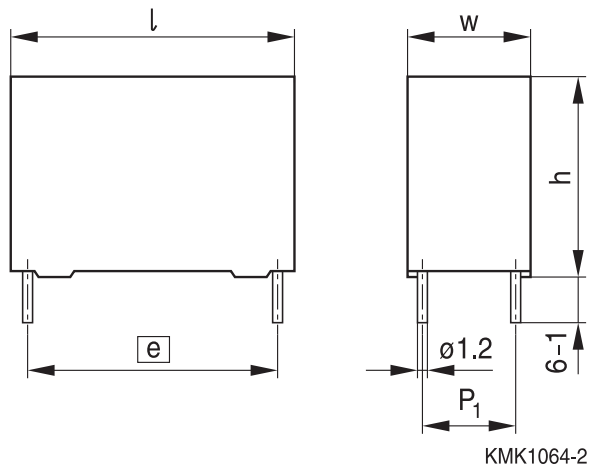
Dimensions drawing 4-pin versions
Drawing B1

	B32656G	B32658G
Lead spacing $e \pm 0.4$	37.5	52.5
Lead diameter d_1 :	1.2	1.2

(Dimensions in mm)

Overview of available types

Lead spacing	10 mm
Type	B32651
V_R (V DC)	1250
V_{RMS} (V AC)	450
C_R (nF)	
2.2	
3.3	
4.7	
6.8	

Overview of available types

Lead spacing	15 mm							
Type	B32652							
V_R (V DC)	250	400	630	1000	1250	1600	1600	2000
V_{RMS} (V AC)	160	200	250	250	500	500	700	700
C_R (nF)								
1.0								
1.5								
2.2								
3.3								
4.7								
5.6								
6.8								
10								
12								
15								
22								
33								
47								
56								
68								
100								
120								
150								
220								
330								
390								
470								
560								
680								
820								
1000								

Overview of available types

Lead spacing	22.5 mm							
Type	B32653							
V_R (V DC)	250	400	630	1000	1250	1600	2000	2000
V_{RMS} (V AC)	160	200	250	250	500	500	700	1000
C_R (nF)								
2.2								
3.3								
4.7								
6.8								
10								
12								
15								
22								
33								
47								
56								
68								
82								
100								
120								
150								
220								
330								
470								
560								
680								
1000								
1200								
1500								
2200								
3300								

Overview of available types

Lead spacing	27.5 mm						
Type	B32654						
V_R (V DC)	250	400	630	1000	1250	1600	2000
V_{RMS} (V AC)	160	200	250	250	500	500	700
C_R (nF)							
22							
33							
47							
68							
82							
100							
150							
220							
330							
470							
560							
680							
820							
1000							
1200							
1500							
2200							
2700							
3300							
4700							
5600							
6800							
8200							

Overview of available types

Lead spacing	37.5 mm			
Type	B32656			
V_R (V DC)	250	400	630	750
V_{RMS} (V AC)	160	200	250	350
C_R (nF)				
470				
560				
680				
820				
1000				
1200				
1500				
1800				
2000				
2200				
2500				
2700				
3000				
3300				
3500				
4000				
4700				
5600				
6800				
7000				
7500				
8000				
10000				
12000				
14000				
15000				
17000				
20000				
24000				

Overview of available types

Lead spacing	37.5 mm				
Type	B32656				
V_R (V DC)	850	1000	1250	1600	2000
V_{RMS} (V AC)	450	500	500	600	700
C_R (nF)					
68					
100					
120					
150					
220					
270					
330					
390					
470					
560					
680					
820					
900					
1000					
1200					
1500					
1800					
2200					
2500					
2700					
3000					
3300					
3800					

Overview of available types

Lead spacing	52.5 mm								
Type	B32658								
V_R (V DC)	250	400	630	750	850	1000	1250	1600	2000
V_{RMS} (V AC)	160	200	250	350	450	500	500	600	700
C_R (nF)									
680									
820									
1000									
1200									
1500									
2000									
2200									
2700									
3300									
4500									
4700									
5600									
6000									
6800									
9000									
12000									
15000									
20000									
26000									
30000									
40000									

Ordering codes and packing units (lead spacing 10 mm)

C_R ¹⁾	Ordering code	Max. dimensions w × h × l	I_{RMS} ²⁾ 85 °C 100 kHz A	ESR_{Typ} 100 kHz mΩ	Ammo pack pcs./MOQ	Reel pcs./MOQ	Untaped pcs./MOQ
nF		mm					
$V_{R, DC} = 1200 \text{ V DC}$ ³⁾ ; $V_{RMS} (f \leq 1 \text{ kHz}) = 450 \text{ V AC}$							
2.2	B32651A7222+***	4.0 × 9.0 × 13.0	0.6	296.8	4000	6800	4000
3.3	B32651A7332+***	5.0 × 11.0 × 13.0	0.8	198.5	3320	5200	4000
4.7	B32651A7472+***	5.0 × 11.0 × 13.0	1.0	142.9	3320	5200	4000
6.8	B32651A7682+***	6.0 × 12.0 × 13.0	1.4	97.3	2720	4400	4000

MOQ = Minimum Order Quantity, consisting of 4 packing units.

Further E series and intermediate capacitance value on request.

Composition of ordering code

+ = Capacitance tolerance code:

J = ±5%

K = ±10%

*** = Packaging code:

289 = Straight terminals, Ammo pack

189 = Straight terminals, Reel

000 = Straight terminals, Untaped
(standard lead length 6 –1 mm)

003 = Straight terminals, Untaped
(lead length 3.2 ±0.3 mm)

004 = Straight terminals, Untaped
(lead length 4.0 ±0.3 mm)

1) Capacitance value measured at 1 kHz

2) Max. ripple current I_{RMS} at 85 °C at 100 kHz for a $\Delta T \leq 20 \text{ °C}$ when $\Delta ESR_{typ} \leq \pm 5\%$

3) For pulse loads (pulse width .1000 μs), a peak voltage of 1400 Up can be permitted

Ordering codes and packing units (lead spacing 15 mm)

C_R ¹⁾	Ordering code	Max. dimensions $w \times h \times l$	I_{RMS} ²⁾ 85 °C 100 kHz	ESR_{Typ} 100 kHz	Ammo pack	Reel	Untaped
nF		mm	A	mΩ	pcs./MOQ	pcs./MOQ	pcs./MOQ
$V_{R, DC} = 250 \text{ V DC} ; V_{RMS} (f \leq 1 \text{ kHz}) = 160 \text{ V AC}$							
150	B32652A3154+***	5.0 × 10.5 × 18.0	3.7	14.9	4680	5200	4000
220	B32652A3224+***	6.0 × 11.0 × 18.0	4.7	10.5	3840	4400	4000
330	B32652A3334+***	7.0 × 12.5 × 18.0	5.6	7.4	3320	3600	4000
470	B32652A3474+***	8.5 × 14.5 × 18.0	6.7	5.6	2720	2800	2000
680	B32652A3684+***	9.0 × 17.5 × 18.0	8.3	4.5	2560	2800	2000
820	B32652A3824+***	11.0 × 18.5 × 18.0	9.5	4.0	-	2200	1200
1000	B32652A3105+***	11.0 × 18.5 × 18.0	10.0	3.6	-	2200	1200
$V_{R, DC} = 400 \text{ V DC} ; V_{RMS} (f \leq 1 \text{ kHz}) = 200 \text{ V AC}$							
68	B32652A4683+***	5.0 × 10.5 × 18.0	2.5	28.1	4680	5200	4000
100	B32652A4104+***	5.0 × 10.5 × 18.0	3.0	19.3	4680	5200	4000
150	B32652A4154+***	6.0 × 11.0 × 18.0	3.9	13.2	3840	4400	4000
220	B32652A4224+***	7.0 × 12.5 × 18.0	5.0	9.4	3320	3600	4000
330	B32652A4334+***	8.5 × 14.5 × 18.0	5.7	6.7	2720	2800	2000
470	B32652A4474+***	9.0 × 17.5 × 18.0	7.2	5.3	2560	2800	2000
560	B32652A4564+***	11.0 × 18.5 × 18.0	8.0	4.7	-	2200	1200
680	B32652A4684+***	11.0 × 18.5 × 18.0	8.7	4.1	-	2200	1200

MOQ = Minimum Order Quantity, consisting of 4 packing units.

Further E series and intermediate capacitance value on request.

Composition of ordering code

+ = Capacitance tolerance code:

J = ±5%

K = ±10%

*** = Packaging code:

289 = Straight terminals, Ammo pack

189 = Straight terminals, Reel

000 = Straight terminals, Untaped
(standard lead length 6 – 1 mm)

003 = Straight terminals, Untaped
(lead length 3.2 ±0.3 mm)

004 = Straight terminals, Untaped
(lead length 4.0 ±0.3 mm)

1) Capacitance value measured at 1 kHz

2) Max. ripple current I_{RMS} at 85 °C at 100 kHz for a $\Delta T \leq 20 \text{ °C}$ when $\Delta ESR_{typ} \leq \pm 5\%$

Ordering codes and packing units (lead spacing 15 mm)

C_R ¹⁾	Ordering code	Max. dimensions w × h × l	I_{RMS} ²⁾ 85 °C 100 kHz	ESR_{Typ} 100 kHz	Ammo pack	Reel	Untaped
nF		mm	A	mΩ	pcs./MOQ	pcs./MOQ	pcs./MOQ

 $V_{R, DC} = 630V DC ; V_{RMS} (f \leq 1 kHz) = 250 V AC$

33	B32652A6333+***	5.0 × 10.5 × 18.0	2.0	50.0	4680	5200	4000
47	B32652A6473+**	6.0 × 10.5 × 18.0	2.4	35.4	4680	5200	4000
68	B32652A6683+***	6.0 × 11.0 × 18.0	3.0	24.8	3840	4400	4000
100	B32652A6104+***	7.0 × 12.5 × 18.0	4.0	17.2	3320	3600	4000
150	B32652A6154+***	8.5 × 14.5 × 18.0	5.3	12.0	2720	2800	2000
220	B32652A6224+***	9.0 × 17.5 × 18.0	6.8	8.7	2560	2800	2000
330	B32652A6334+***	11.0 × 18.5 × 18.0	8.0	6.3	-	2200	1200
390	B32652A6394+***	11.0 × 18.5 × 18.0	8.5	6.1	-	2200	1200

 $V_{R, DC} = 1000 V DC ; V_{RMS} (f \leq 1 kHz) = 250 V AC$

10	B32652A0103+***	5.0 × 10.5 × 18.0	1.3	127.1	4680	5200	4000
15	B32652A0153+***	5.0 × 10.5 × 18.0	1.6	85.0	4680	5200	4000
22	B32652A0223+***	5.0 × 10.5 × 18.0	1.9	59.6	4680	5200	4000
33	B32652A0333+***	6.0 × 11.0 × 18.0	2.5	39.1	3840	4400	4000
47	B32652A0473+***	7.0 × 12.5 × 18.0	3.2	27.8	3320	3600	4000
68	B32652A0683+***	8.5 × 14.5 × 18.0	4.2	19.7	2720	2800	2000
100	B32652A0104+***	9.0 × 17.5 × 18.0	5.4	14.0	2560	2800	2000
120	B32652A0124+***	11.0 × 18.5 × 18.0	6.3	12.0	-	2200	1200
150	B32652A0154+***	11.0 × 18.5 × 18.0	7.0	9.8	-	2200	1200

MOQ = Minimum Order Quantity, consisting of 4 packing units.

Further E series and intermediate capacitance value on request.

Composition of ordering code

+ = Capacitance tolerance code:

J = ±5%

K = ±10%

*** = Packaging code:

289 = Straight terminals, Ammo pack

189 = Straight terminals, Reel

000 = Straight terminals, Untaped
(standard lead length 6 –1 mm)

003 = Straight terminals, Untaped
(lead length 3.2 ±0.3 mm)

004 = Straight terminals, Untaped
(lead length 4.0 ±0.3 mm)

1) Capacitance value measured at 1 kHz

2) Max. ripple current I_{RMS} at 85 °C at 100 kHz for a $\Delta T \leq 20$ °C when $\Delta ESR_{typ} \leq \pm 5\%$

Ordering codes and packing units (lead spacing 15 mm)

C_R ¹⁾	Ordering code	Max. dimensions $w \times h \times l$	I_{RMS} ²⁾ 85 °C 100 kHz A	ESR_{Typ} 100 kHz mΩ	Ammo pack pcs./MOQ	Reel pcs./MOQ	Untaped pcs./MOQ
nF		mm					
$V_{R, DC} = 1250 \text{ V DC} ; V_{RMS} (f \leq 1 \text{ kHz}) = 500 \text{ V AC}$							
6.8	B32652A7682+***	5.0 × 10.5 × 18.0	1.4	112.5	4680	5200	4000
10	B32652A7103+***	6.0 × 11.0 × 18.0	1.8	76.8	3840	4400	4000
15	B32652A7153+***	7.0 × 12.5 × 18.0	2.4	51.6	3320	3600	4000
22	B32652A7223+***	8.5 × 14.5 × 18.0	3.2	35.6	2720	2800	2000
33	B32652A7333+***	9.0 × 17.5 × 18.0	4.2	24.4	2560	2800	2000
47	B32652A7473+***	11.0 × 18.5 × 18.0	5.4	17.6	-	2200	1200
56	B32652A7563+***	11.0 × 18.5 × 18.0	5.7	15.0	-	2200	1200
$V_{R, DC} = 1600 \text{ V DC} ; V_{RMS} (f \leq 1 \text{ kHz}) = 500 \text{ V AC}$							
3.3	B32652A1332+***	5.0 × 10.5 × 18.0	0.9	206.6	4680	5200	4000
4.7	B32652A1472+***	6.0 × 11.0 × 18.0	1.4	145.3	3840	4400	4000
6.8	B32652A1682+***	7.0 × 12.5 × 18.0	1.7	100.8	3320	3600	4000
10	B32652A1103+***	8.5 × 14.5 × 18.0	2.1	69.0	2720	2800	2000
15	B32652A1153+***	9.0 × 17.5 × 18.0	2.8	46.6	2560	2800	2000
22	B32652A1223+***	11.0 × 18.5 × 18.0	3.6	32.3	-	2200	1200

MOQ = Minimum Order Quantity, consisting of 4 packing units.
Further E series and intermediate capacitance value on request.

Composition of ordering code

+ = Capacitance tolerance code:

J = ±5%

K = ±10%

*** = Packaging code:

289 = Straight terminals, Ammo pack

189 = Straight terminals, Reel

000 = Straight terminals, Untaped
(standard lead length 6 – 1 mm)

003 = Straight terminals, Untaped
(lead length 3.2 ± 0.3 mm)

004 = Straight terminals, Untaped
(lead length 4.0 ± 0.3 mm)

1) Capacitance value measured at 1 kHz

2) Max. ripple current I_{RMS} at 85 °C at 100 kHz for a $\Delta T \leq 20 \text{ °C}$ when $\Delta ESR_{typ} \leq \pm 5\%$

Ordering codes and packing units (lead spacing 15 mm)

C_R ¹⁾	Ordering code	Max. dimensions w × h × l	I_{RMS} ²⁾ 85 °C 100 kHz	ESR_{Typ} 100 kHz	Ammo pack	Reel	Untaped
nF		mm	A	mΩ	pcs./MOQ	pcs./MOQ	pcs./MOQ
$V_{R, DC} = 1600$ V DC ; V_{RMS} (f ≤ 1 kHz) = 700 V AC							
2.2	B32652J1222+***	5.0 × 10.5 × 18.0	0.7	269.5	4680	5200	4000
3.3	B32652J1332+***	6.0 × 11.0 × 18.0	1.1	179.9	3840	4400	4000
4.7	B32652J1472+***	7.0 × 12.5 × 18.0	1.4	126.7	3320	3600	4000
6.8	B32652J1682+***	8.5 × 14.5 × 18.0	1.8	88.0	2720	2800	2000
10	B32652J1103+***	9.0 × 17.5 × 18.0	2.4	60.5	2560	2800	2000
12	B32652J1123+***	9.0 × 17.5 × 18.0	2.6	50.6	2560	2800	2000
15	B32652J1153+***	11.0 × 18.5 × 18.0	3.1	40.8	-	2200	1200
$V_{R, DC} = 2000$ V DC ; V_{RMS} (f ≤ 1 kHz) = 700 V AC							
1.0	B32652A2102+***	5.0 × 10.5 × 18.0	0.4	605.7	4680	5200	4000
1.5	B32652A2152+***	6.0 × 11.0 × 18.0	0.7	404.1	3840	4400	4000
2.2	B32652A2222+***	7.0 × 12.5 × 18.0	0.9	275.9	3320	3600	4000
3.3	B32652A2332+***	8.5 × 14.5 × 18.0	1.2	184.4	2720	2800	2000
4.7	B32652A2472+***	9.0 × 17.5 × 18.0	1.6	130.0	2560	2800	2000
5.6	B32652A2562+***	9.0 × 17.5 × 18.0	1.7	111.3	2560	2800	2000
6.8	B32652A2682+***	11.0 × 18.5 × 18.0	2.1	90.4	-	2200	1200

MOQ = Minimum Order Quantity, consisting of 4 packing units.

Further E series and intermediate capacitance value on request.

Composition of ordering code

+ = Capacitance tolerance code:

J = ±5%

K = ±10%

*** = Packaging code:

289 = Straight terminals, Ammo pack

189 = Straight terminals, Reel

000 = Straight terminals, Untaped
(standard lead length 6 – 1 mm)

003 = Straight terminals, Untaped
(lead length 3.2 ± 0.3 mm)

004 = Straight terminals, Untaped
(lead length 4.0 ± 0.3 mm)

1) Capacitance value measured at 1 kHz

2) Max. ripple current I_{RMS} at 85 °C at 100 kHz for a $\Delta T \leq 20$ °C when $\Delta ESR_{typ} \leq \pm 5\%$

Ordering codes and packing units (lead spacing 22.5 mm)

C_R ¹⁾	Ordering code	Max. dimensions w × h × l	I_{RMS} ²⁾ 85 °C 100 kHz	ESR_{Typ} 100 kHz	Ammo pack	Reel	Untaped
nF		mm	A	mΩ	pcs./MOQ	pcs./MOQ	pcs./MOQ

 $V_{R, DC} = 250 \text{ V DC} ; V_{RMS} (f \leq 1 \text{ kHz}) = 160 \text{ V AC}$

220	B32653A3224+***	6.0 × 15.0 × 26.5	3.9	24.8	2720	2800	2880
330	B32653A3334+***	6.0 × 15.0 × 26.5	4.8	16.9	2720	2800	2880
470	B32653A3474+***	7.0 × 16.0 × 26.5	6.0	12.3	2320	2400	2520
680	B32653A3684+***	8.5 × 16.5 × 26.5	7.4	8.9	1920	2000	2040
1000	B32653A3105+***	10.5 × 16.5 × 26.5	8.0	6.5	1560	1600	2160
1200	B32653A3125+***	10.5 × 18.5 × 26.5	8.8	5.8	1560	1600	2160
1500	B32653A3155+***	11.0 × 20.5 × 26.5	10.0	5.1	1480	1400	2040
2200	B32653A3225+***	14.5 × 29.5 × 26.5	11.0	4.7	-	-	1040
3300	B32653A3335+***	14.5 × 29.5 × 26.5	13.0	3.9	-	-	1040

 $V_{R, DC} = 400 \text{ V DC} ; V_{RMS} (f \leq 1 \text{ kHz}) = 200 \text{ V AC}$

150	B32653A4154+***	6.0 × 15.0 × 26.5	2.9	34.6	2720	2800	2880
220	B32653A4224+***	6.0 × 15.0 × 26.5	3.5	30.7	2720	2800	2880
330	B32653A4334+***	7.0 × 16.0 × 26.5	4.5	20.9	2320	2400	2520
470	B32653A4474+***	8.5 × 16.5 × 26.5	5.3	15.1	1920	2000	2040
680	B32653A4684+***	10.5 × 16.5 × 26.5	7.0	10.8	1560	1600	2160
1000	B32653A4105+***	11.0 × 20.5 × 26.5	8.8	8.1	1480	1400	2040
1200	B32653A4125+***	12.0 × 22.0 × 26.5	9.3	7.1	-	-	1800
1500	B32653A4155+***	14.5 × 29.5 × 26.5	11.0	6.6	-	-	1040
2200	B32653A4225+***	14.5 × 29.5 × 26.5	12.0	5.2	-	-	1040

MOQ = Minimum Order Quantity, consisting of 4 packing units.

Further E series and intermediate capacitance value on request.

Composition of ordering code

+ = Capacitance tolerance code:

J = ±5%

K = ±10%

*** = Packaging code:

289 = Straight terminals, Ammo pack

189 = Straight terminals, Reel

000 = Straight terminals, Untaped
(standard lead length 6 –1 mm)

003 = Straight terminals, Untaped
(lead length 3.2 ±0.3 mm)

004 = Straight terminals, Untaped
(lead length 4.0 ±0.3 mm)

1) Capacitance value measured at 1 kHz

2) Max. ripple current I_{RMS} at 85 °C at 100 kHz for a $\Delta T \leq 20 \text{ °C}$ when $\Delta ESR_{Typ} \leq \pm 5\%$

Ordering codes and packing units (lead spacing 22.5 mm)

C_R ¹⁾	Ordering code	Max. dimensions w × h × l	I_{RMS} ²⁾	ESR_{Typ}	Ammo pack	Reel	Untaped
nF		mm	85 °C 100 kHz A	100 kHz mΩ	pcs./MOQ	pcs./MOQ	pcs./MOQ
$V_{R, DC} = 630 \text{ V DC} ; V_{RMS} (f \leq 1 \text{ kHz}) = 250 \text{ V AC}$							
100	B32653A6104+***	6.0 × 15.0 × 26.5	2.3	51.3	2720	2800	2880
150	B32653A6154+***	6.0 × 15.0 × 26.5	3.3	34.6	2720	2800	2880
220	B32653A6224+***	8.5 × 16.5 × 26.5	4.4	24.0	1920	2000	2040
330	B32653A6334+***	10.5 × 16.5 × 26.5	5.6	16.5	1560	1600	2160
470	B32653A6474+***	11.0 × 20.5 × 26.5	7.1	12.2	1480	1400	2040
560	B32653A6564+***	11.0 × 20.5 × 26.5	7.7	10.5	1480	1400	2040
680	B32653A6684+***	14.5 × 29.5 × 26.5	9.0	12.2	-	-	1040
1000	B32653A6105+***	14.5 × 29.5 × 26.5	10.0	7.3	-	-	1040
1200	B32653A6125+***	14.5 × 29.5 × 26.5	10.6	6.4	-	-	1040
$V_{R, DC} = 1000 \text{ V DC} ; V_{RMS} (f \leq 1 \text{ kHz}) = 250 \text{ V AC}$							
33	B32653A0333+***	6.0 × 15.0 × 26.5	1.6	47.3	2720	2800	2880
47	B32653A0473+***	6.0 × 15.0 × 26.5	2.0	95.3	2720	2800	2880
68	B32653A0683+***	6.0 × 15.0 × 26.5	2.3	66.2	2720	2800	2880
100	B32653A0104+***	8.5 × 16.5 × 26.5	3.2	45.5	1920	2000	2040
150	B32653A0154+***	10.5 × 16.5 × 26.5	4.1	30.8	1560	1600	2160
220	B32653A0224+***	11.0 × 20.5 × 26.5	5.3	21.7	1480	1400	2040
330	B32653A0334+***	14.5 × 29.5 × 26.5	7.7	15.7	-	-	1040
470	B32653A0474+***	14.5 × 29.5 × 26.5	9.0	11.7	-	-	1040
560	B32653A0564+***	14.5 × 29.5 × 26.5	9.6	10.2	-	-	1040

MOQ = Minimum Order Quantity, consisting of 4 packing units.

Further E series and intermediate capacitance value on request.

Composition of ordering code

+ = Capacitance tolerance code:

J = ±5%

K = ±10%

*** = Packaging code:

289 = Straight terminals, Ammo pack

189 = Straight terminals, Reel

000 = Straight terminals, Untaped
(standard lead length 6 – 1 mm)

003 = Straight terminals, Untaped
(lead length 3.2 ±0.3 mm)

004 = Straight terminals, Untaped
(lead length 4.0 ±0.3 mm)

1) Capacitance value measured at 1 kHz

2) Max. ripple current I_{RMS} at 85 °C at 100 kHz for a $\Delta T \leq 20 \text{ °C}$ when $\Delta ESR_{typ} \leq \pm 5\%$

Ordering codes and packing units (lead spacing 22.5 mm)

C_R ¹⁾	Ordering code	Max. dimensions w × h × l	I_{RMS} ²⁾ 85 °C 100 kHz	ESR_{Typ} 100 kHz	Ammo pack	Reel	Untaped
nF		mm	A	mΩ	pcs./MOQ	pcs./MOQ	pcs./MOQ

 $V_{R, DC} = 1250 \text{ V DC} ; V_{RMS} (f \leq 1 \text{ kHz}) = 500 \text{ V AC}$

22	B32653A7223+***	6.0 × 15.0 × 26.5	2.8	52.1	2720	2800	2800
33	B32653A7333+***	6.0 × 15.0 × 26.5	3.4	35.1	2720	2800	2800
47	B32653A7473+***	8.5 × 16.5 × 26.5	4.6	25.1	1920	2000	2040
68	B32653A7683+***	10.5 × 16.5 × 26.5	5.7	17.7	1560	1600	2160
100	B32653A7104+***	11.0 × 20.5 × 26.5	7.3	12.8	1480	1400	2040
120	B32653A7124+**	12.0 × 22.0 × 26.5	8.3	11.0	-	-	1800
150	B32653A7154+***	14.5 × 29.5 × 26.5	10.3	9.7	-	-	1040
220	B32653A7224+***	14.5 × 29.5 × 26.5	12.0	7.4	-	-	1040

 $V_{R, DC} = 1600 \text{ V DC} ; V_{RMS} (f \leq 1 \text{ kHz}) = 500 \text{ V AC}$

6.8	B32653A1682+***	6.0 × 15.0 × 26.5	1.5	181.8	2720	2800	2880
10	B32653A1103+***	6.0 × 15.0 × 26.5	1.8	124.0	2720	2800	2880
15	B32653A1153+***	7.0 × 16.0 × 26.5	2.4	83.1	2320	2400	2520
22	B32653A1223+***	8.5 × 16.5 × 26.5	3.0	57.1	1920	2000	2040
33	B32653A1333+***	10.5 × 16.5 × 26.5	3.8	38.5	1560	1600	2160
47	B32653A1473+***	11.0 × 20.5 × 26.5	5.0	27.7	1480	1400	2040
56	B32653A1563+***	12.0 × 22.0 × 26.5	5.6	23.6	-	-	1800
68	B32653A1683+***	14.5 × 29.5 × 26.5	7.1	20.3	-	-	1040
82	B32653A1823+***	14.5 × 29.5 × 26.5	7.7	17.3	-	-	1040
100	B32653A1104+***	14.5 × 29.5 × 26.5	8.4	14.6	-	-	1040

MOQ = Minimum Order Quantity, consisting of 4 packing units.

Further E series and intermediate capacitance value on request.

Composition of ordering code

+ = Capacitance tolerance code:

J = ±5%

K = ±10%

*** = Packaging code:

289 = Straight terminals, Ammo pack

189 = Straight terminals, Reel

000 = Straight terminals, Untaped
(standard lead length 6 –1 mm)

003 = Straight terminals, Untaped
(lead length 3.2 ±0.3 mm)

004 = Straight terminals, Untaped
(lead length 4.0 ±0.3 mm)

1) Capacitance value measured at 1 kHz

2) Max. ripple current I_{RMS} at 85 °C at 100 kHz for a $\Delta T \leq 20$ °C when $\Delta ESR_{typ} \leq \pm 5\%$

Ordering codes and packing units (lead spacing 22.5 mm)

C_R ¹⁾	Ordering code	Max. dimensions $w \times h \times l$	I_{RMS} ²⁾ 85 °C 100 kHz A	ESR_{Typ} 100 kHz mΩ	Ammo pack pcs./MOQ	Reel pcs./MOQ	Untaped pcs./MOQ
nF		mm					
$V_{R, DC} = 2000 \text{ V DC} ; V_{RMS} (f \leq 1 \text{ kHz}) = 700 \text{ V AC}$							
3.3	B32653A2332+***	6.0 × 15.0 × 26.5	1.2	209.7	2720	2800	2880
4.7	B32653A2472+***	6.0 × 15.0 × 26.5	1.6	150.7	2720	2800	2880
6.8	B32653A2682+***	8.5 × 16.5 × 26.5	2.2	102.5	1920	2000	2040
10	B32653A2103+***	10.5 × 16.5 × 26.5	2.8	70.1	1560	1600	2160
15	B32653A2153+***	11.0 × 20.5 × 26.5	3.7	47.4	1480	1400	2040
22	B32653A2223+***	14.5 × 29.5 × 26.5	5.4	33.5	-	-	1040
33	B32653A2333+***	14.5 × 29.5 × 26.5	6.5	23.1	-	-	1040
$V_{R, DC} = 2000 \text{ V DC} ; V_{RMS} (f \leq 1 \text{ kHz}) = 1000 \text{ V AC}$							
2.2	B32653A8222+***	6.0 × 15.0 × 26.5	1.1	344.6	2720	2800	2880
3.3	B32653A8332+***	6.0 × 15.0 × 26.5	1.2	229.8	2720	2800	2880
4.7	B32653A8472+***	8.5 × 16.5 × 26.5	1.6	161.7	1920	2000	2040
6.8	B32653A8682+***	10.5 × 16.5 × 26.5	2.0	112.1	1560	1600	2160
10	B32653A8103+***	10.5 × 20.5 × 26.5	2.6	76.9	1560	1600	2160
12	B32653A8123+***	12.0 × 22.0 × 26.5	3.0	64.5	-	-	1800
15	B32653A8153+***	14.5 × 29.5 × 26.5	4.0	52.5	-	-	1040
22	B32653A8223+***	14.5 × 29.5 × 26.5	4.7	36.5	-	-	1040

MOQ = Minimum Order Quantity, consisting of 4 packing units.

Further E series and intermediate capacitance value on request.

Composition of ordering code

+ = Capacitance tolerance code:

J = ±5%

K = ±10%

*** = Packaging code:

289 = Straight terminals, Ammo pack

189 = Straight terminals, Reel

000 = Straight terminals, Untaped
(standard lead length 6 – 1 mm)

003 = Straight terminals, Untaped
(lead length 3.2 ±0.3 mm)

004 = Straight terminals, Untaped
(lead length 4.0 ±0.3 mm)

1) Capacitance value measured at 1 kHz

2) Max. ripple current I_{RMS} at 85 °C at 100 kHz for a $\Delta T \leq 20 \text{ °C}$ when $\Delta ESR_{typ} \leq \pm 5\%$

Ordering codes and packing units (lead spacing 27.5 mm)

C_R ¹⁾	Ordering code	Max. dimensions w × h × l	I_{RMS} ²⁾	ESR_{Typ}	Ammo pack	Reel	Untaped
nF		mm	85 °C 100 kHz A	100 kHz mΩ	pcs./MOQ	pcs./MOQ	pcs./MOQ
$V_{R, DC} = 250$ V DC ; V_{RMS} (f ≤ 1 kHz) = 160 V AC							
1500	B32654A3155+***	11.0 × 21.0 × 31.5	7.4	6.9	-	1400	1280
2200	B32654A3225+***	12.5 × 21.5 × 31.5	9.8	5.3	-	1200	1120
3300	B32654A3335+***	15.0 × 24.5 × 31.5	10.8	4.4	-	-	960
4700	B32654A3475+***	18.0 × 27.5 × 31.5	12.7	3.9	-	-	800
5600	B32654A3565+***	19.0 × 30.0 × 31.5	13.6	3.8	-	-	720
6800	B32654A3685+***	22.0 × 36.5 × 31.5	15.0	4.0	-	-	640
8200	B32654A3825+***	22.0 × 36.5 × 31.5	16.0	3.8	-	-	640
$V_{R, DC} = 400$ V DC ; V_{RMS} (f ≤ 1 kHz) = 200 V AC							
1000	B32654A4105+***	11.0 × 21.0 × 31.5	8.5	8.3	-	1400	1280
1500	B32654A4155+***	12.5 × 21.5 × 31.5	9.0	6.1	-	1200	1120
2200	B32654A4225+***	14.0 × 24.5 × 31.5	10.3	5.1	-	1000	1040
3300	B32654A4335+***	19.0 × 30.0 × 31.5	11.3	4.4	-	-	720
4700	B32654A4475+***	22.0 × 36.5 × 31.5	14.0	4.3	-	-	640
5600	B32654A4565+***	22.0 × 36.5 × 31.5	15.4	4.0	-	-	640
$V_{R, DC} = 630$ V DC ; V_{RMS} (f ≤ 1 kHz) = 250 V AC							
680	B32654A6684+***	11.0 × 21.0 × 31.5	8.0	9.2	-	1400	1280
1000	B32654A6105+***	13.5 × 23.0 × 31.5	10.0	6.9	-	1000	1120
1500	B32654A6155+***	18.0 × 27.5 × 31.5	11.0	5.6	-	-	800
2200	B32654A6225+***	18.0 × 33.0 × 31.5	12.0	4.9	-	-	800
2700	B32654A6275+***	22.0 × 36.5 × 31.5	13.0	4.7	-	-	640
3300	B32654A6335K***	22.0 × 36.5 × 31.5	14.0	4.4	-	-	640

MOQ = Minimum Order Quantity, consisting of 4 packing units.

Further E series and intermediate capacitance value on request.

Composition of ordering code

+ = Capacitance tolerance code:

J = ±5%

K = ±10%

*** = Packaging code:

289 = Straight terminals, Ammo pack

189 = Straight terminals, Reel

000 = Straight terminals, Untaped
(standard lead length 6 – 1 mm)

003 = Straight terminals, Untaped
(lead length 3.2 ± 0.3 mm)

004 = Straight terminals, Untaped
(lead length 4.0 ± 0.3 mm)

1) Capacitance value measured at 1 kHz

2) Max. ripple current I_{RMS} at 85 °C at 100 kHz for a $\Delta T \leq 20$ °C when $\Delta ESR_{typ} \leq \pm 5\%$

Ordering codes and packing units (lead spacing 27.5 mm)

C_R ¹⁾	Ordering code	Max. dimensions $w \times h \times l$	I_{RMS} ²⁾ 85 °C 100 kHz	ESR_{Typ} 100 kHz	Ammo pack	Reel	Untaped
nF		mm	A	mΩ	pcs./MOQ	pcs./MOQ	pcs./MOQ
$V_{R, DC} = 1000 \text{ V DC} ; V_{RMS} (f \leq 1 \text{ kHz}) = 250 \text{ V AC}$							
220	B32654A0224+***	11.0 × 21.0 × 31.5	7.3	10.5	-	1400	1280
330	B32654A0334+***	12.5 × 21.0 × 31.5	8.6	7.6	-	1400	1280
470	B32654A0474+***	14.0 × 24.5 × 31.5	9.4	6.1	-	1000	1040
680	B32654A0684+***	18.0 × 27.5 × 31.5	11.0	5.0	-	-	800
820	B32654A0824+***	19.0 × 30.0 × 31.5	12.0	4.7	-	-	720
1000	B32654A0105+***	21.0 × 30.1 × 31.5	14.0	4.3	-	-	720
1200	B32654A0125+***	22.0 × 36.5 × 31.5	15.0	4.4	-	-	640
1500	B32654A0155K***	22.0 × 36.5 × 31.5	15.5	4.2	-	-	640
$V_{R, DC} = 1250 \text{ V DC} ; V_{RMS} (f \leq 1 \text{ kHz}) = 500 \text{ V AC}$							
100	B32654A7104+***	11.0 × 21.0 × 31.5	5.5	19.1	-	1400	1280
150	B32654A7154+***	11.0 × 21.0 × 31.5	6.4	13.3	-	1200	1280
220	B32654A7224+***	14.0 × 24.5 × 31.5	8.7	9.8	-	1000	1040
330	B32654A7334+***	18.0 × 27.5 × 31.5	9.7	7.4	-	-	800
470	B32654A7474+***	21.0 × 31.0 × 31.5	11.6	6.1	-	-	720
560	B32654A7564+***	22.0 × 36.5 × 31.5	12.6	5.9	-	-	640
680	B32654A7684+***	22.0 × 36.5 × 31.5	14.6	5.4	-	-	640

MOQ = Minimum Order Quantity, consisting of 4 packing units.

Further E series and intermediate capacitance value on request.

Composition of ordering code

+ = Capacitance tolerance code:

J = ±5%

K = ±10%

*** = Packaging code:

289 = Straight terminals, Ammo pack

189 = Straight terminals, Reel

000 = Straight terminals, Untaped
(standard lead length 6 –1 mm)

003 = Straight terminals, Untaped
(lead length 3.2 ±0.3 mm)

004 = Straight terminals, Untaped
(lead length 4.0 ±0.3 mm)

1) Capacitance value measured at 1 kHz

2) Max. ripple current I_{RMS} at 85 °C at 100 kHz for a $\Delta T \leq 20$ °C when $\Delta ESR_{typ} \leq \pm 5\%$

Ordering codes and packing units (lead spacing 27.5 mm)

C_R ¹⁾	Ordering code	Max. dimensions w × h × l	I_{RMS} ²⁾ 85 °C 100 kHz	ESR_{Typ} 100 kHz	Ammo pack	Reel	Untaped
nF		mm	A	mΩ	pcs./MOQ	pcs./MOQ	pcs./MOQ
$V_{R, DC} = 1600 \text{ V DC} ; V_{RMS} (f \leq 1 \text{ kHz}) = 500 \text{ V AC}$							
47	B32654A1473+***	11.0 × 21.0 × 31.5	4.6	38.7	-	1400	1280
68	B32654A1683+***	11.0 × 21.0 × 31.5	5.5	27.3	-	1400	1280
100	B32654A1104+***	14.0 × 24.5 × 31.5	7.3	19.3	-	1000	1040
150	B32654A1154+***	18.0 × 27.5 × 31.5	9.5	13.8	-	-	800
220	B32654A1224+***	21.0 × 31.0 × 31.5	12.0	10.3	-	-	720
$V_{R, DC} = 2000 \text{ V DC} ; V_{RMS} (f \leq 1 \text{ kHz}) = 700 \text{ V AC}$							
22	B32654A2223+***	11.0 × 21.0 × 31.5	4.6	46.1	-	1400	1280
33	B32654A2333+***	13.5 × 23.0 × 31.5	4.6	31.4	-	1000	1040
47	B32654A2473+***	18.0 × 27.5 × 31.5	6.4	22.9	-	-	800
68	B32654A2683+***	19.0 × 30.0 × 31.5	7.8	16.7	-	-	720
82	B32654A2823+***	22.0 × 36.5 × 31.5	9.3	14.7	-	-	640
100	B32654A2104+***	22.0 × 36.5 × 31.5	10.0	12.6	-	-	640

MOQ = Minimum Order Quantity, consisting of 4 packing units.

Further E series and intermediate capacitance value on request.

Composition of ordering code

+ = Capacitance tolerance code:

J = ±5%

K = ±10%

*** = Packaging code:

289 = Straight terminals, Ammo pack

189 = Straight terminals, Reel

000 = Straight terminals, Untaped
(standard lead length 6 – 1 mm)

003 = Straight terminals, Untaped
(lead length 3.2 ± 0.3 mm)

004 = Straight terminals, Untaped
(lead length 4.0 ± 0.3 mm)

1) Capacitance value measured at 1 kHz

2) Max. ripple current I_{RMS} at 85 °C at 100 kHz for a $\Delta T \leq 20 \text{ °C}$ when $\Delta ESR_{typ} \leq \pm 5\%$

Ordering codes and packing units (lead spacing 37.5 mm)

C_R ¹⁾	Ordering code	Max. dimensions w × h × l	P1	I_{RMS} ²⁾	ESR _{Typ}	Untaped
nF		mm	mm	85 °C 100 kHz A	100 kHz mΩ	pcs./MOQ
$V_{R, DC} = 250 \text{ V DC} ; V_{RMS} (f \leq 1 \text{ kHz}) = 160 \text{ V AC}$						
2700	B32656A3275+***	12.0 × 22.0 × 42.0	-	9.3	6.8	1620
3000	B32656A3305+***	12.0 × 22.0 × 42.0	-	9.8	6.2	1620
3300	B32656A3335+***	14.0 × 25.0 × 42.0	-	10.5	5.9	1380
4000	B32656A3405+***	14.0 × 25.0 × 42.0	-	11.9	5.1	1380
4000	B32656T3405+***	24.0 × 15.0 × 42.0	-	12.0	4.6	1040
4700	B32656A3475+***	16.0 × 28.5 × 42.0	-	12.8	4.7	800
5600	B32656A3565+***	16.0 × 28.5 × 42.0	-	14.0	4.2	800
5600	B32656T3565+***	24.0 × 19.0 × 42.0	-	14.5	3.7	780
6800	B32656A3685+***	18.0 × 32.5 × 42.0	-	14.5	3.9	720
8000	B32656A3805+***	18.0 × 32.5 × 42.0	-	15.0	3.6	720
10000	B32656G3106+***	20.0 × 39.5 × 42.0	10.2	15.5	2.2	640
10000	B32656A3106+***	20.0 × 39.5 × 42.0	-	15.3	3.5	640
12000	B32656G3126K***	20.0 × 39.5 × 42.0	10.2	19.7	2.0	640
12000	B32656A3126K***	20.0 × 39.5 × 42.0	-	16.0	3.3	640
15000	B32656G3156K***	28.0 × 37.0 × 42.0	10.2	23.4	1.8	440
15000	B32656A3156K***	28.0 × 37.0 × 42.0	-	18.0	3.0	440
17000	B32656G3176+***	28.0 × 42.5 × 42.0	10.2	24.8	1.6	440
17000	B32656A3176+***	28.0 × 42.5 × 42.0	-	20.0	3.0	440
20000	B32656G3206+***	30.0 × 45.0 × 42.0	20.3	27.0	1.6	400
20000	B32656A3206+***	30.0 × 45.0 × 42.0	-	20.0	3.0	400
24000	B32656G3246+***	33.0 × 48.0 × 42.0	20.3	29.5	1.5	180
24000	B32656A3246+***	33.0 × 48.0 × 42.0	-	21.0	3.1	180

MOQ = Minimum Order Quantity, consisting of 4 packing units.
Further E series and intermediate capacitance value on request.

Composition of ordering code

+ = Capacitance tolerance code:

J = ±5%

K = ±10%

*** = Packaging code:

000 = Straight terminals, Untaped
(standard lead length 6 – 1 mm)

003 = Straight terminals, Untaped
(lead length 3.2 ± 0.3 mm)

004 = Straight terminals, Untaped
(lead length 4.0 ± 0.3 mm)

1) Capacitance value measured at 1 kHz

2) Max. ripple current I_{RMS} at 85 °C at 100 kHz for a $\Delta T \leq 20 \text{ °C}$ when $\Delta ESR_{typ} \leq \pm 5\%$

Ordering codes and packing units (lead spacing 37.5 mm)

C_R ¹⁾	Ordering code	Max. dimensions w × h × l	P1	I_{RMS} ²⁾	ESR_{Typ}	Untaped
nF		mm	mm	85 °C 100 kHz A	100 kHz mΩ	pcs./MOQ
$V_{R, DC} = 400 \text{ V DC}$; $V_{RMS} (f \leq 1 \text{ kHz}) = 200 \text{ V AC}$						
2000	B32656A4205+***	12.0 × 22.0 × 42.0	-	9.9	7.5	1620
2700	B32656A4275+***	14.0 × 25.0 × 42.0	-	11.0	6.0	1380
2700	B32656T4275+***	24.0 × 15.0 × 42.0	-	11.5	5.5	1040
3500	B32656T4355+***	24.0 × 19.0 × 42.0	-	12.0	4.6	780
4000	B32656A4405+***	16.0 × 28.5 × 42.0	-	12.5	4.6	800
5600	B32656A4565+***	18.0 × 32.5 × 42.0	-	15.4	3.9	720
7500	B32656G4755+***	20.0 × 39.5 × 42.0	10.2	20.0	2.4	640
7500	B32656A4755+***	20.0 × 39.5 × 42.0	-	16.7	3.7	640
10000	B32656G4106+***	28.0 × 37.0 × 42.0	10.2	22.0	1.9	440
10000	B32656A4106+***	28.0 × 37.0 × 42.0	-	17.5	3.1	440
12000	B32656G4126+***	28.0 × 42.5 × 42.0	10.2	23.5	1.8	440
12000	B32656A4126+***	28.0 × 42.5 × 42.0	-	18.5	3.2	440
14000	B32656G4146+***	30.0 × 45.0 × 42.0	20.3	25.5	1.7	400
14000	B32656A4146+***	30.0 × 45.0 × 42.0	-	19.0	3.2	400
17000	B32656G4176+***	33.0 × 48.0 × 42.0	20.3	28.5	1.6	180
17000	B32656A4176+***	33.0 × 48.0 × 42.0	-	20.5	3.2	180

MOQ = Minimum Order Quantity, consisting of 4 packing units.
Further E series and intermediate capacitance value on request.

Composition of ordering code

+ = Capacitance tolerance code:

J = ±5%

K = ±10%

*** = Packaging code:

000 = Straight terminals, Untaped
(standard lead length 6 –1 mm)

003 = Straight terminals, Untaped
(lead length 3.2 ±0.3 mm)

004 = Straight terminals, Untaped
(lead length 4.0 ±0.3 mm)

1) Capacitance value measured at 1 kHz

2) Max. ripple current I_{RMS} at 85 °C at 100 kHz for a $\Delta T \leq 20 \text{ °C}$ when $\Delta ESR_{typ} \leq \pm 5\%$

Ordering codes and packing units (lead spacing 37.5 mm)

C_R ¹⁾	Ordering code	Max. dimensions w × h × l	P1	I_{RMS} ²⁾	ESR_{Typ}	Untaped
nF		mm	mm	85 °C 100 kHz A	100 kHz mΩ	pcs./MOQ
$V_{R, DC} = 630 \text{ V DC}$; $V_{RMS} (f \leq 1 \text{ kHz}) = 250 \text{ V AC}$						
1000	B32656A6105+***	12.0 × 22.0 × 42.0	-	9.5	10.9	1620
1500	B32656A6155+***	14.0 × 25.0 × 42.0	-	10.0	7.8	1380
1500	B32656T6155+***	24.0 × 15.0 × 42.0	-	11.0	7.3	1040
2200	B32656T6225+***	24.0 × 19.0 × 42.0	-	13.6	5.4	780
2200	B32656A6225+***	16.0 × 28.5 × 42.0	-	13.0	5.9	800
3000	B32656A6305+***	18.0 × 32.5 × 42.0	-	14.0	4.9	720
4000	B32656G6405+***	20.0 × 39.5 × 42.0	10.2	17.0	3.1	640
4000	B32656A6405+***	20.0 × 39.5 × 42.0	-	15.0	4.4	640
5600	B32656G6565+***	28.0 × 37.0 × 42.0	10.2	19.7	2.4	440
5600	B32656A6565+***	28.0 × 37.0 × 42.0	-	16.4	3.6	440
7000	B32656G6705K***	28.0 × 42.5 × 42.0	10.2	21.5	2.2	440
7000	B32656A6705K***	28.0 × 42.5 × 42.0	-	17.3	3.6	440
8000	B32656G6805+***	30.0 × 45.0 × 42.0	20.3	23.3	2.0	400
8000	B32656A6805+***	30.0 × 45.0 × 42.0	-	18.5	3.5	400
10000	B32656G6106K***	33.0 × 48.0 × 42.0	20.3	26.0	1.9	180
10000	B32656A6106K***	33.0 × 48.0 × 42.0	-	19.7	3.4	180

MOQ = Minimum Order Quantity, consisting of 4 packing units.
Further E series and intermediate capacitance value on request.

Composition of ordering code

+ = Capacitance tolerance code:

J = ±5%

K = ±10%

*** = Packaging code:

000 = Straight terminals, Untaped
(standard lead length 6 –1 mm)

003 = Straight terminals, Untaped
(lead length 3.2 ±0.3 mm)

004 = Straight terminals, Untaped
(lead length 4.0 ±0.3 mm)

1) Capacitance value measured at 1 kHz

2) Max. ripple current I_{RMS} at 85 °C at 100 kHz for a $\Delta T \leq 20 \text{ °C}$ when $\Delta ESR_{typ} \leq \pm 5\%$

Ordering codes and packing units (lead spacing 37.5 mm)

C_R ¹⁾	Ordering code	Max. dimensions w × h × l	P1	I_{RMS} ²⁾	ESR_{Typ}	Untaped
nF		mm	mm	85 °C 100 kHz A	100 kHz mΩ	pcs./MOQ
$V_{R, DC} = 750 \text{ V DC} ; V_{RMS} (f \leq 1 \text{ kHz}) = 350 \text{ V AC}$						
470	B32656A5474+***	12.0 × 22.0 × 42.0	-	7.0	14.6	1620
560	B32656A5564+***	12.0 × 22.0 × 42.0	-	7.6	12.4	1620
680	B32656A5684+***	12.0 × 22.0 × 42.0	-	8.2	10.4	1620
820	B32656A5824+***	14.0 × 25.0 × 42.0	-	9.8	9.0	1380
1000	B32656A5105+***	16.0 × 28.5 × 42.0	-	12.0	7.8	800
1000	B32656T5105K***	24.0 × 15.0 × 42.0	-	10.6	7.3	1040
1200	B32656A5125+***	16.0 × 28.5 × 42.0	-	13.0	6.7	800
1200	B32656T5125+***	24.0 × 19.0 × 42.0	-	12.5	6.2	780
1500	B32656A5155+***	18.0 × 32.5 × 42.0	-	14.7	5.8	720
1800	B32656A5185+***	18.0 × 32.5 × 42.0	-	16.0	5.1	720
2200	B32656G5225+***	20.0 × 39.5 × 42.0	10.2	18.6	3.6	640
2200	B32656A5225+***	20.0 × 39.5 × 42.0	-	17.5	4.8	640
2500	B32656G5255+***	20.0 × 39.5 × 42.0	10.2	18.7	3.6	640
2500	B32656A5255+***	20.0 × 39.5 × 42.0	-	17.8	4.5	640
2700	B32656G5275+***	28.0 × 37.0 × 42.0	10.2	21.0	3.0	440
2700	B32656A5275+***	28.0 × 37.0 × 42.0	-	19.0	4.2	440
3300	B32656G5335+***	28.0 × 37.0 × 42.0	10.2	22.7	2.6	440
3300	B32656A5335+***	28.0 × 37.0 × 42.0	-	20.0	3.8	440
4000	B32656G5405+***	28.0 × 42.5 × 42.0	10.2	24.6	2.3	440
4000	B32656A5405+***	28.0 × 42.5 × 42.0	-	20.5	3.7	440
4700	B32656G5475+***	30.0 × 45.0 × 42.0	20.3	27.7	2.1	400
4700	B32656A5475+***	30.0 × 45.0 × 42.0	-	21.9	3.6	400
5600	B32656G5565+***	33.0 × 48.0 × 42.0	20.3	30.4	2.0	180
5600	B32656A5565+***	33.0 × 48.0 × 42.0	-	23.5	3.5	180

MOQ = Minimum Order Quantity, consisting of 4 packing units.

Further E series and intermediate capacitance value on request.

Composition of ordering code

+ = Capacitance tolerance code:

J = ±5%

K = ±10%

*** = Packaging code:

000 = Straight terminals, Untaped
(standard lead length 6 –1 mm)

003 = Straight terminals, Untaped
(lead length 3.2 ±0.3 mm)

004 = Straight terminals, Untaped
(lead length 4.0 ±0.3 mm)

1) Capacitance value measured at 1 kHz

2) Max. ripple current I_{RMS} at 85 °C at 100 kHz for a $\Delta T \leq 20 \text{ °C}$ when $\Delta ESR_{typ} \leq \pm 5\%$

Ordering codes and packing units (lead spacing 37.5 mm)

C_R ¹⁾	Ordering code	Max. dimensions w × h × l	P1	I_{RMS} ²⁾ 85 °C 100 kHz	ESR_{Typ} 100 kHz	Untaped
nF		mm	mm	A	mΩ	pcs./MOQ
$V_{R, DC} = 850 \text{ V DC} ; V_{RMS} (f \leq 1 \text{ kHz}) = 450 \text{ V AC}$						
220	B32656A8224+***	12.0 × 22.0 × 42.0	-	5.2	25.6	1620
330	B32656A8334+***	12.0 × 22.0 × 42.0	-	6.3	17.4	1620
470	B32656A8474+***	12.0 × 22.0 × 42.0	-	7.5	12.6	1620
680	B32656A8684+***	16.0 × 28.5 × 42.0	-	10.0	9.3	800
680	B32656T8684+***	24.0 × 15.0 × 42.0	-	9.6	8.8	1040
820	B32656T8824+***	24.0 × 19.0 × 42.0	-	11.0	7.5	780
1000	B32656A8105+***	18.0 × 32.5 × 42.0	-	11.6	7.0	720
1200	B32656A8125+***	18.0 × 32.5 × 42.0	-	12.5	6.1	720
1500	B32656G8155+***	20.0 × 39.5 × 42.0	10.2	15.4	4.3	640
1500	B32656A8155+***	20.0 × 39.5 × 42.0	-	14.0	5.5	640
1800	B32656G8185+***	20.0 × 39.5 × 42.0	10.2	16.7	3.7	640
1800	B32656A8185+***	20.0 × 39.5 × 42.0	-	14.9	4.9	640
2200	B32656G8225+***	28.0 × 37.0 × 42.0	10.2	19.7	3.1	440
2200	B32656A8225+***	28.0 × 37.0 × 42.0	-	17.8	4.3	440
2500	B32656G8255+***	28.0 × 42.5 × 42.0	10.2	20.4	2.9	440
2500	B32656A8255+***	28.0 × 42.5 × 42.0	-	18.7	4.3	440
2700	B32656G8275+***	30.0 × 45.0 × 42.0	20.3	21.6	2.8	400
2700	B32656A8275+***	30.0 × 45.0 × 42.0	-	20.0	4.2	400
3000	B32656G8305+***	30.0 × 45.0 × 42.0	20.3	22.7	2.6	400
3000	B32656A8305+***	30.0 × 45.0 × 42.0	-	20.5	4.0	400
3300	B32656G8335+***	33.0 × 48.0 × 42.0	20.3	23.0	2.5	180
3300	B32656A8335+***	33.0 × 48.0 × 42.0	-	21.0	4.0	180
3800	B32656G8385+***	33.0 × 48.0 × 42.0	20.3	24.4	2.2	180
3800	B32656A8385+***	33.0 × 48.0 × 42.0	-	21.4	3.8	180

MOQ = Minimum Order Quantity, consisting of 4 packing units.

Further E series and intermediate capacitance value on request.

Composition of ordering code

+ = Capacitance tolerance code:

J = ±5%

K = ±10%

*** = Packaging code:

000 = Straight terminals, Untaped
(standard lead length 6 –1 mm)

003 = Straight terminals, Untaped
(lead length 3.2 ±0.3 mm)

004 = Straight terminals, Untaped
(lead length 4.0 ±0.3 mm)

1) Capacitance value measured at 1 kHz

2) Max. ripple current I_{RMS} at 85 °C at 100 kHz for a $\Delta T \leq 20 \text{ °C}$ when $\Delta ESR_{typ} \leq \pm 5\%$

Ordering codes and packing units (lead spacing 37.5 mm)

C_R ¹⁾	Ordering code	Max. dimensions w × h × l	P1	I_{RMS} ²⁾	ESR_{Typ}	Untaped
nF		mm	mm	85 °C 100 kHz A	100 kHz mΩ	pcs./MOQ
$V_{R, DC} = 1000 \text{ V DC} ; V_{RMS} (f \leq 1 \text{ kHz}) = 500 \text{ V AC}$						
330	B32656A0334+***	12.0 × 22.0 × 42.0	-	7.8	15.3	1620
470	B32656A0474+***	12.0 × 25.0 × 42.0	-	9.0	11.2	1380
470	B32656T0474+***	24.0 × 15.0 × 42.0	-	9.0	10.7	1040
680	B32656T0684+***	24.0 × 19.0 × 42.0	-	9.6	8.1	780
680	B32656A0684+***	16.0 × 28.5 × 42.0	-	9.5	8.5	800
1000	B32656G0105+***	20.0 × 39.5 × 42.0	10.2	13.0	5.4	640
1000	B32656A0105+***	20.0 × 39.5 × 42.0	-	12.2	6.6	640
1200	B32656G0125+***	28.0 × 37.0 × 42.0	10.2	15.5	4.6	440
1200	B32656A0125+***	28.0 × 37.0 × 42.0	-	12.6	5.7	440
1500	B32656G0155+***	28.0 × 37.0 × 42.0	10.2	16.9	3.8	440
1500	B32656A0155+***	28.0 × 37.0 × 42.0	-	13.5	5.0	440
2200	B32656G0225+***	30.0 × 45.0 × 42.0	20.3	20.0	2.9	400
2200	B32656A0225+***	30.0 × 45.0 × 42.0	-	16.0	4.4	400
2700	B32656G0275M***	30.0 × 45.0 × 42.0	20.3	21.0	2.8	400
2700	B32656A0275M***	30.0 × 45.0 × 42.0	-	17.5	4.3	400
2700	B32656G0275+***	33.0 × 48.0 × 42.0	20.3	22.8	2.6	180
2700	B32656A0275+***	33.0 × 48.0 × 42.0	-	17.5	4.1	180

MOQ = Minimum Order Quantity, consisting of 4 packing units.
Further E series and intermediate capacitance value on request.

Composition of ordering code

+ = Capacitance tolerance code:

J = ±5%

K = ±10%

*** = Packaging code:

000 = Straight terminals, Untaped
(standard standard lead length 6 –1 mm)

003 = Straight terminals, Untaped
(lead length 3.2 ±0.3 mm)

004 = Straight terminals, Untaped
(lead length 4.0 ±0.3 mm)

1) Capacitance value measured at 1 kHz

2) Max. ripple current I_{RMS} at 85 °C at 100 kHz for a $\Delta T \leq 20 \text{ °C}$ when $\Delta ESR_{typ} \leq \pm 5\%$

Ordering codes and packing units (lead spacing 37.5 mm)

C_R ¹⁾	Ordering code	Max. dimensions w × h × l	P1	I_{RMS} ²⁾	ESR_{Typ}	Untaped
nF		mm	mm	85 °C 100 kHz A	100 kHz mΩ	pcs./MOQ
$V_{R, DC} = 1250 \text{ V DC} ; V_{RMS} (f \leq 1 \text{ kHz}) = 500 \text{ V AC}$						
150	B32656A7154+***	12.0 × 22.0 × 42.0	-	6.0	26.2	1620
220	B32656A7224+***	14.0 × 25.0 × 42.0	-	7.8	18.4	1380
270	B32656T7274+***	24.0 × 15.0 × 42.0	-	8.6	14.7	1040
330	B32656A7334+***	16.0 × 28.5 × 42.0	-	9.9	12.8	800
390	B32656T7394+***	24.0 × 19.0 × 42.0	-	10.0	10.6	780
470	B32656A7474+***	18.0 × 32.5 × 42.0	-	12.3	9.6	720
680	B32656G7684+***	20.0 × 39.5 × 42.0	10.2	15.0	6.2	640
680	B32656A7684+***	20.0 × 39.5 × 42.0	-	14.0	7.5	640
820	B32656G7824+***	28.0 × 37.0 × 42.0	10.2	17.0	5.2	440
820	B32656A7824+***	28.0 × 37.0 × 42.0	-	15.6	6.4	440
1000	B32656G7105+***	28.0 × 37.0 × 42.0	10.2	18.4	4.4	440
1000	B32656A7105+***	28.0 × 37.0 × 42.0	-	16.7	5.6	440
1200	B32656G7125+***	28.0 × 42.5 × 42.0	10.2	19.0	3.9	440
1200	B32656A7125+***	28.0 × 42.5 × 42.0	-	17.0	5.2	440
1500	B32656G7155+***	30.0 × 45.0 × 42.0	20.3	21.0	3.4	400
1500	B32656A7155+***	30.0 × 45.0 × 42.0	-	18.0	4.8	400
1800	B32656G7185K***	33.0 × 48.0 × 42.0	20.3	23.0	3.0	180
1800	B32656A7185K***	33.0 × 48.0 × 42.0	-	19.0	4.6	180

MOQ = Minimum Order Quantity, consisting of 4 packing units.
Further E series and intermediate capacitance value on request.

Composition of ordering code

+ = Capacitance tolerance code:

J = ±5%

K = ±10%

*** = Packaging code:

000 = Straight terminals, Untaped
(standard lead length 6 –1 mm)

003 = Straight terminals, Untaped
(lead length 3.2 ±0.3 mm)

004 = Straight terminals, Untaped
(lead length 4.0 ±0.3 mm)

1) Capacitance value measured at 1 kHz

2) Max. ripple current I_{RMS} at 85 °C at 100 kHz for a $\Delta T \leq 20 \text{ °C}$ when $\Delta ESR_{typ} \leq \pm 5\%$

Ordering codes and packing units (lead spacing 37.5 mm)

C_R ¹⁾	Ordering code	Max. dimensions w × h × l	P1	I_{RMS} ²⁾	ESR_{Typ}	Untaped
nF		mm	mm	85 °C 100 kHz A	100 kHz mΩ	pcs./MOQ
$V_{R, DC} = 1600V DC ; V_{RMS} (f \leq 1 kHz) = 600 V AC$						
100	B32656J1104+***	12.0 × 22.0 × 42.0	-	6.0	24.5	1620
150	B32656J1154+***	14.0 × 25.0 × 42.0	-	7.6	16.9	1380
150	B32656T1154+***	24.0 × 15.0 × 42.0	-	7.8	16.4	1040
220	B32656J1224+***	16.0 × 28.5 × 42.0	-	9.5	12.4	800
220	B32656T1224+***	24.0 × 19.0 × 42.0	-	9.8	12.1	780
330	B32656G1334+***	20.0 × 39.5 × 42.0	10.2	11.0	7.8	640
330	B32656J1334+***	20.0 × 39.5 × 42.0	-	10.4	9.0	640
470	B32656G1474+***	28.0 × 37.0 × 42.0	10.2	13.4	5.6	440
470	B32656J1474+***	28.0 × 37.0 × 42.0	-	12.3	6.8	440
560	B32656G1564+***	28.0 × 37.0 × 42.0	10.2	14.3	4.8	440
560	B32656J1564+***	28.0 × 42.5 × 42.0	-	13.0	6.0	440
680	B32656G1684+***	28.0 × 42.5 × 42.0	10.2	16.6	4.4	440
680	B32656J1684+***	28.0 × 42.5 × 42.0	-	15.0	5.8	440
820	B32656G1824K***	30.0 × 45.0 × 42.0	20.3	18.7	3.9	400
820	B32656J1824K***	30.0 × 45.0 × 42.0	-	16.4	5.3	400
900	B32656G1904+***	33.0 × 48.0 × 42.0	20.3	21.0	3.6	180
900	B32656J1904+***	33.0 × 48.0 × 42.0	-	18.8	5.2	180

MOQ = Minimum Order Quantity, consisting of 4 packing units.
Further E series and intermediate capacitance value on request.

Composition of ordering code

+ = Capacitance tolerance code:

J = ±5%

K = ±10%

*** = Packaging code:

000 = Straight terminals, Untaped
(standard lead length 6 –1 mm)

003 = Straight terminals, Untaped
(lead length 3.2 ±0.3 mm)

004 = Straight terminals, Untaped
(lead length 4.0 ±0.3 mm)

1) Capacitance value measured at 1 kHz

2) Max. ripple current I_{RMS} at 85 °C at 100 kHz for a $\Delta T \leq 20$ °C when $\Delta ESR_{typ} \leq \pm 5\%$

Ordering codes and packing units (lead spacing 37.5 mm)

C_R ¹⁾	Ordering code	Max. dimensions w × h × l	P1	I_{RMS} ²⁾	ESR_{Typ}	Untaped
nF		mm	mm	85 °C 100 kHz A	100 kHz mΩ	pcs./MOQ
$V_{R, DC} = 2000 \text{ V DC} ; V_{RMS} (f \leq 1 \text{ kHz}) = 700 \text{ V AC}$						
68	B32656J2683+***	12.0 × 22.0 × 42.0	-	5.7	36.7	1620
100	B32656J2104+***	14.0 × 25.0 × 42.0	-	7.4	25.4	1380
100	B32656T2104+***	24.0 × 15.0 × 42.0	-	7.4	25.4	1040
120	B32656T2124+***	24.0 × 19.0 × 42.0	-	8.7	21.1	780
150	B32656J2154+***	18.0 × 32.5 × 42.0	-	9.8	17.7	720
220	B32656G2224+***	20.0 × 39.5 × 42.0	10.2	13.3	11.7	640
220	B32656J2224+***	20.0 × 39.5 × 42.0	-	12.7	13.0	640
330	B32656G2334+***	28.0 × 37.0 × 42.0	10.2	14.3	8.0	440
330	B32656J2334+***	28.0 × 37.0 × 42.0	-	13.4	9.2	440
470	B32656G2474+***	30.0 × 45.0 × 42.0	20.3	16.5	5.9	400
470	B32656J2474+***	30.0 × 45.0 × 42.0	-	14.7	7.4	400
560	B32656G2564+***	33.0 × 48.0 × 42.0	20.3	18.7	5.2	180
560	B32656J2564+***	33.0 × 48.0 × 42.0	-	16.3	6.7	180

MOQ = Minimum Order Quantity, consisting of 4 packing units.
Further E series and intermediate capacitance value on request.

Composition of ordering code

+ = Capacitance tolerance code:

J = ±5%

K = ±10%

*** = Packaging code:

000 = Straight terminals, Untaped
(standard lead length 6 – 1 mm)

003 = Straight terminals, Untaped
(lead length 3.2 ± 0.3 mm)

004 = Straight terminals, Untaped
(lead length 4.0 ± 0.3 mm)

1) Capacitance value measured at 1 kHz

2) Max. ripple current I_{RMS} at 85 °C at 100 kHz for a $\Delta T \leq 20 \text{ °C}$ when $\Delta ESR_{typ} \leq \pm 5\%$

Ordering codes and packing units (lead spacing 52.5 mm)

C_R ¹⁾	Ordering code	Max. dimensions w × h × l	P1	I_{RMS} ²⁾	ESR_{Typ}	Untaped
nF		mm	mm	85 °C 100 kHz A	100 kHz mΩ	pcs./MOQ
$V_{R, DC} = 250 \text{ V DC} ; V_{RMS} (f \leq 1 \text{ kHz}) = 160 \text{ V AC}$						
30000	B32658G3306+***	30.0 × 45.0 × 57.5	20.3	26.0	1.8	280
40000	B32658G3406K***	35.0 × 50.0 × 57.5	20.3	30.0	1.7	108
$V_{R, DC} = 400 \text{ V DC} ; V_{RMS} (f \leq 1 \text{ kHz}) = 200 \text{ V AC}$						
20000	B32658G4206+***	30.0 × 45.0 × 57.5	20.3	26.0	2.0	280
26000	B32658G4266+***	35.0 × 50.0 × 57.5	20.3	30.0	1.9	108
$V_{R, DC} = 630 \text{ V DC} ; V_{RMS} (f \leq 1 \text{ kHz}) = 250 \text{ V AC}$						
12000	B32658G6126K***	30.0 × 45.0 × 57.5	20.3	23.7	2.4	280
15000	B32658G6156+***	35.0 × 50.0 × 57.5	20.3	27.7	2.1	108
$V_{R, DC} = 750 \text{ V DC} ; V_{RMS} (f \leq 1 \text{ kHz}) = 350 \text{ V AC}$						
6800	B32658G5685+***	30.0 × 45.0 × 57.5	20.3	22.0	2.6	280
9000	B32658G5905+***	35.0 × 50.0 × 57.5	20.3	26.5	2.3	108
$V_{R, DC} = 850 \text{ V DC} ; V_{RMS} (f \leq 1 \text{ kHz}) = 450 \text{ V AC}$						
4700	B32658G8475+***	30.0 × 45.0 × 57.5	20.3	28.0	3.0	280
5600	B32658G8565+***	35.0 × 50.0 × 57.5	20.3	31.5	2.7	108
6000	B32658G8605+***	35.0 × 50.0 × 57.5	20.3	32.5	2.6	108
$V_{R, DC} = 1000 \text{ V DC} ; V_{RMS} (f \leq 1 \text{ kHz}) = 500 \text{ V AC}$						
3300	B32658G0335+***	30.0 × 45.0 × 57.5	20.3	23.0	3.5	280
4500	B32658G0455+***	35.0 × 50.0 × 57.5	20.3	27.7	2.9	108

MOQ = Minimum Order Quantity, consisting of 4 packing units.
Further E series and intermediate capacitance value on request.

Composition of ordering code

+ = Capacitance tolerance code:

J = ±5%

K = ±10%

*** = Packaging code:

000 = Straight terminals, Untaped
(standard lead length 6 –1 mm)

003 = Straight terminals, Untaped
(lead length 3.2 ±0.3 mm)

004 = Straight terminals, Untaped
(lead length 4.0 ±0.3 mm)

1) Capacitance value measured at 1 kHz

2) Max. ripple current I_{RMS} at 85 °C at 100 kHz for a $\Delta T \leq 20 \text{ °C}$ when $\Delta ESR_{typ} \leq \pm 5\%$

Ordering codes and packing units (lead spacing 52.5 mm)

C_R ¹⁾	Ordering code	Max. dimensions w × h × l	P1	I_{RMS} ²⁾ 85 °C 100 kHz A	ESR_{Typ} 100 kHz mΩ	Untaped pcs./MOQ
nF		mm	mm			
$V_{R, DC} = 1250 \text{ V DC} ; V_{RMS} (f \leq 1 \text{ kHz}) = 500 \text{ V AC}$						
2000	B32658G7205+***	30.0 × 45.0 × 57.5	20.3	23.0	3.4	280
2200	B32658G7225+***	35.0 × 50.0 × 57.5	20.3	25.7	3.2	108
2700	B32658G7275+***	35.0 × 50.0 × 57.5	20.3	28.0	2.8	108
$V_{R, DC} = 1600 \text{ V DC} ; V_{RMS} (f \leq 1 \text{ kHz}) = 600 \text{ V AC}$						
1000	B32658G1105+***	30.0 × 45.0 × 57.5	20.3	21.0	5.3	280
1200	B32658G1125K***	30.0 × 45.0 × 57.5	20.3	22.5	5.3	280
1500	B32658G1155+***	35.0 × 50.0 × 57.5	20.3	26.5	3.9	108
$V_{R, DC} = 2000 \text{ V DC} ; V_{RMS} (f \leq 1 \text{ kHz}) = 700 \text{ V AC}$						
680	B32658G2684+***	30.0 × 45.0 × 57.5	20.3	19.0	6.2	280
820	B32658G2824+***	35.0 × 50.0 × 57.5	20.3	22.0	5.4	108
1000	B32658G2105K***	35.0 × 50.0 × 57.5	20.3	24.5	4.7	108

MOQ = Minimum Order Quantity, consisting of 4 packing units.
Further E series and intermediate capacitance value on request.

Composition of ordering code

+ = Capacitance tolerance code:

J = ±5%

K = ±10%

*** = Packaging code:

000 = Straight terminals, Untaped
(standard lead length 6 –1 mm)

003 = Straight terminals, Untaped
(lead length 3.2 ±0.3 mm)

004 = Straight terminals, Untaped
(lead length 4.0 ±0.3 mm)

1) Capacitance value measured at 1 kHz

2) Max. ripple current I_{RMS} at 85 °C at 100 kHz for a $\Delta T \leq 20 \text{ °C}$ when $\Delta ESR_{typ} \leq \pm 5\%$

Technical data

 Reference: IEC60384-16:2005 and AEC-Q200. All data given at $T = 20\text{ °C}$, unless otherwise specified.

Rated temperature T_R	85 °C				
Operation temperature range	At $T > 85\text{ °C}$ derating for V_{DC} should be 1.25% / °C				
Max. operating temperature $T_{op,max}$	+110 °C				
Upper category temperature T_{max}	+100 °C				
Lower category temperature T_{min}	-40 °C				
Dissipation factor $\tan \delta$ (in 10^{-3}) at 20 °C (upper limit values)	at	$\leq 27\text{ nF}$	$27\text{ nF} \leq C_R \leq 0.1\text{ }\mu\text{F}$	$0.1\text{ }\mu\text{F} \leq C_R \leq 1\text{ }\mu\text{F}$	$C_R > 1\text{ }\mu\text{F}$
	1 kHz	0.8	0.8	0.8	0.8
	10 kHz	1.0	1.0	1.0	-
	100 kHz	2.0	3.0	-	-
Insulation resistance R_{ins} or time constant $\tau = C_R \cdot R_{ins}$ at 20 °C, rel. humidity $\leq 65\%$ (minimum as-delivered values)	$C_R \leq 0.33\text{ }\mu\text{F}$		$C_R > 0.33\text{ }\mu\text{F}$		
	100 G Ω		30000 s		
DC test voltage	Between terminals: $1.6 \cdot V_R$, 2 s				
Biased humidity test	56 days 60 °C / 95% relative humidity with V_R				
Limit values after humidity test	Capacitance change $ \Delta C/C $:		$\leq 10\%$		
	Dissipation factor change $\Delta \tan \delta$		≤ 0.005 (at 1 kHz)		
	Insulation resistance R_{ins} or time constant $\tau = C_R \cdot R_{ins}$		$\geq 50\%$ of minimum specified limit		
Reliability Failure rate λ Service life t_{SL}	1 fit ($\leq 1 \cdot 10^{-9}/h$) at $0.5 \cdot V_R$, 40 °C 200000 h at $1.0 \cdot V_R$, 85 °C For conversion to other operating conditions and temperatures, refer to chapter "Quality, 2 Reliability".				
Failure criteria Total failure	Short circuit or open circuit				
Failure due to variation of parameters	Capacitance change $ \Delta C/C $		$> 10\%$		
	Dissipation factor $\tan \delta$		$> 4 \cdot$ upper limit values		
	Insulation resistance R_{ins}		$< 1500\text{ M}\Omega$ ($C_R \leq 0.33\text{ }\mu\text{F}$)		
	or time constant τ		$< 500\text{ s}$ ($C_R \geq 0.33\text{ }\mu\text{F}$)		

 Note: 1000 hrs / 85 °C / 85% relative humidity with V_R available on request, based on special design.

Pulse handling capability

“dV/dt” represents the maximum permissible voltage change per unit of time for non-sinusoidal voltage, expressed in V/ μ s.

“k0” represents the maximum permissible pulse characteristic of the waveform applied to the capacitor, expressed in V 2 / μ s

Note:

The values of dV/dt and k0 provided below must not be exceeded in order to avoid damaging the capacitor.

dV/dt values

Lead spacing		10 mm	15 mm	22.5 mm	27.5 mm	37.5 mm	52.5 mm
V_R V DC	V_{RMS} V AC	dV/dt in V/ μ s					
250	160	-	200	120	50	36	24
400	200	-	300	180	100	55	36
630	250	-	400	300	150	80	50
750	350	-	-	-	-	250	160
850	450	-	-	-	-	340	220
1000	250	-	975	600	300	-	-
	500	-	-	-	-	400	265
1250	450	4000	-	-	-	-	-
	500	-	1850	1150	600	500	350
1600	500	-	4500	2400	1000	-	-
	600	-	-	-	-	600	400
	700	-	-	-	-	-	-
2000	700	-	8000	7000	2300	700	475
	1000	-	-	7500	-	-	-

K_0 values

Lead spacing		10 mm	15 mm	22.5 mm	27.5 mm	37.5 mm	52.5 mm
V_R V DC	V_{RMS} V AC	K_0 in $V^2/\mu s$					
250	160	-	100000	60000	25000	18000	12000
400	200	-	250000	200000	110000	44000	28800
630	250	-	500000	350000	250000	100800	63000
750	350	-	-	-	-	375000	240000
850	450	-	-	-	-	578000	374000
1000	250	-	3000000	1500000	1000000	-	-
	500	-	-	-	-	800000	530000
1250	450	25000000	-	-	-	-	-
	500	-	9000000	3750000	2000000	1250000	875000
1600	500	-	20000000	10000000	4000000	-	-
	600	-	-	-	-	1920000	1280000
	700	-	28000000	-	-	-	-
2000	700	-	60000000	40000000	15000000	2800000	1900000
	1000	-	-	50000000	-	-	-

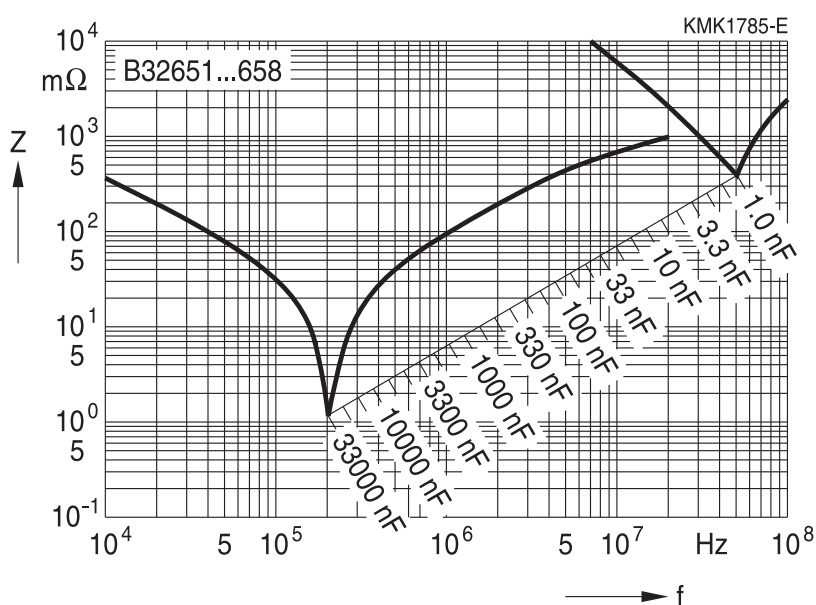
**Impedance Z versus frequency f
(typical values)**

Permissible AC voltage V_{RMS} versus frequency f (for sinusoidal waveforms, ambient temperature $T_A \leq 85\text{ }^\circ\text{C}$, self-heating $\Delta T \leq 20\text{ }^\circ\text{C}$ when $\Delta ESR_{typ} \leq \pm 5\%$)

Lead spacing 10 mm

1250 V DC/450 V AC

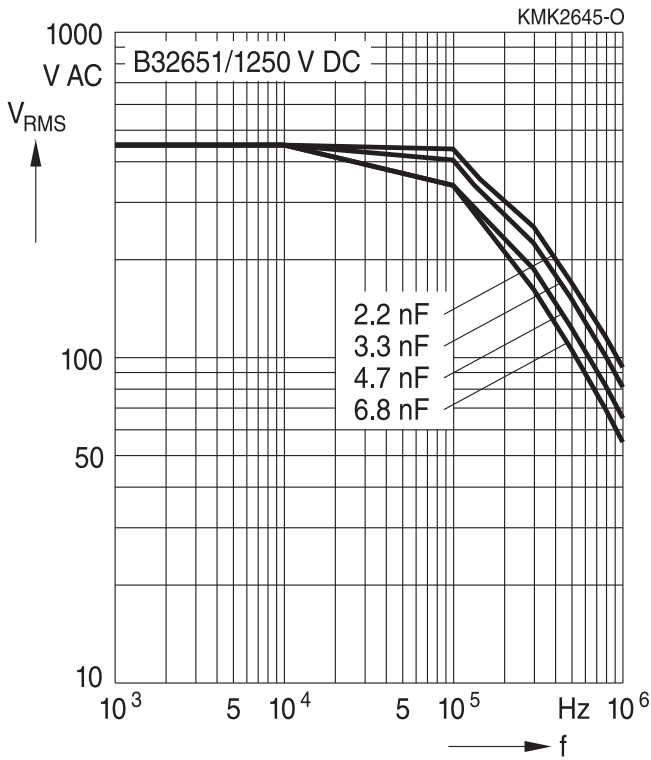

**Permissible AC voltage V_{RMS} versus frequency f (for sinusoidal waveforms, ambient temperature $T_A \leq 85^\circ\text{C}$, self-heating $\Delta T \leq 20^\circ\text{C}$ when $\Delta ESR_{typ} \leq \pm 5\%$)
Lead spacing 15 mm**

250 V DC/160 V AC

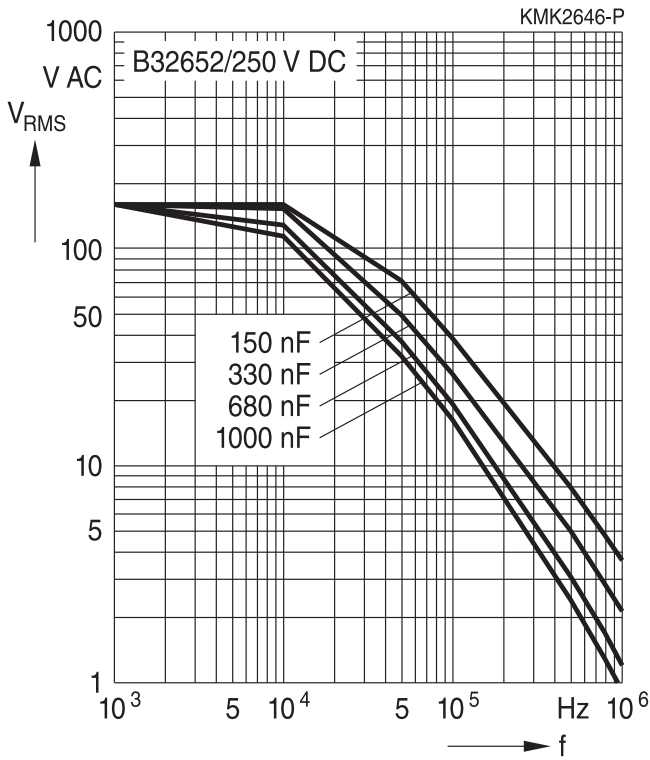

400 V DC/200 V AC

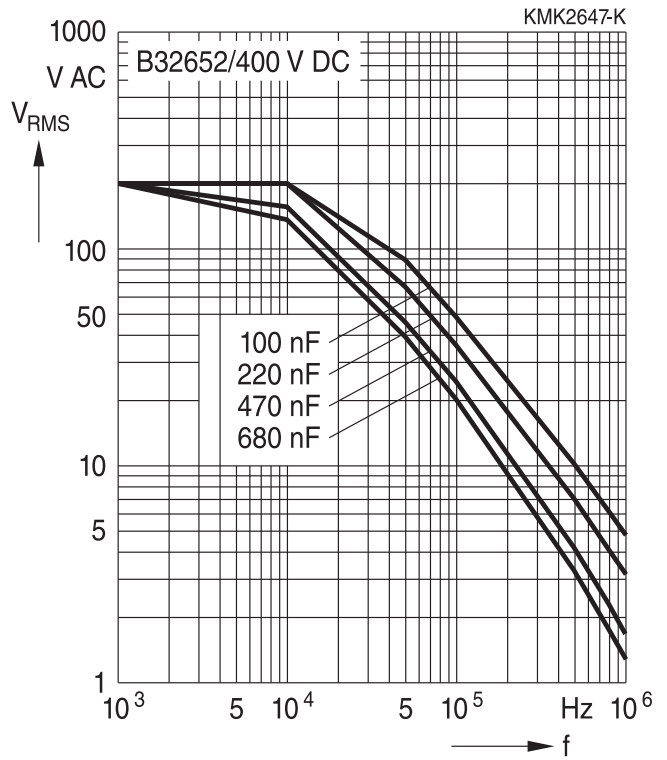

630 V DC/250 V AC

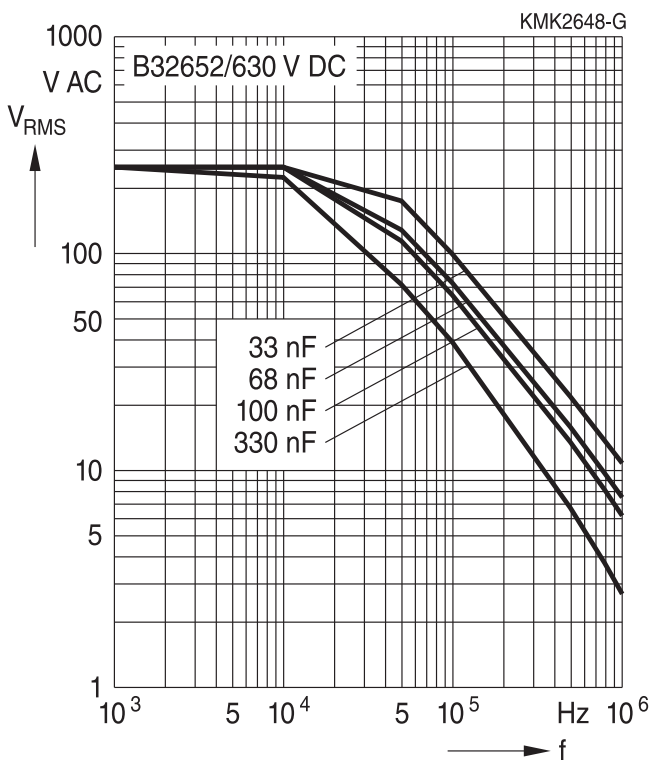

1000 V DC/250 V AC

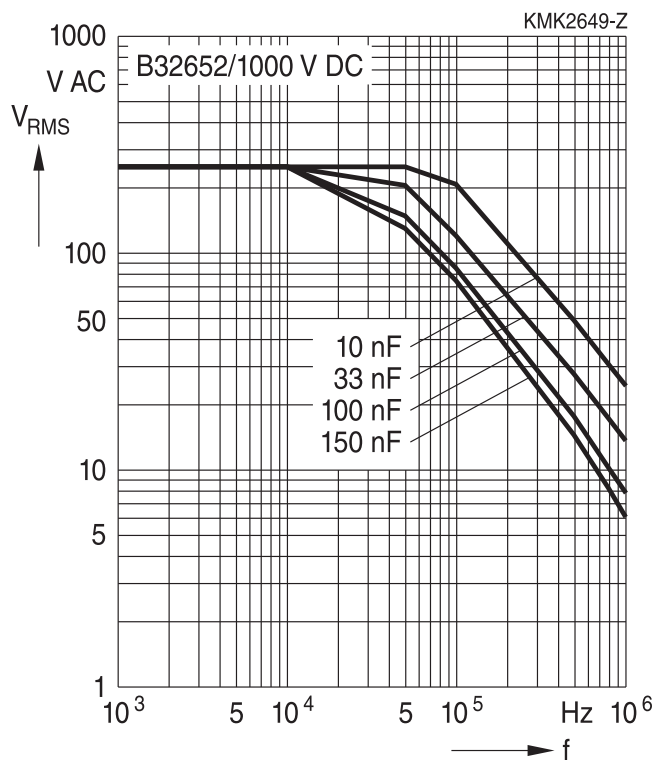

Permissible AC voltage V_{RMS} versus frequency f (for sinusoidal waveforms, ambient temperature $T_A \leq 85^\circ\text{C}$, self-heating $\Delta T \leq 20^\circ\text{C}$ when $\Delta ESR_{typ} \leq \pm 5\%$)
Lead spacing 15 mm

1250 V DC/500 V AC

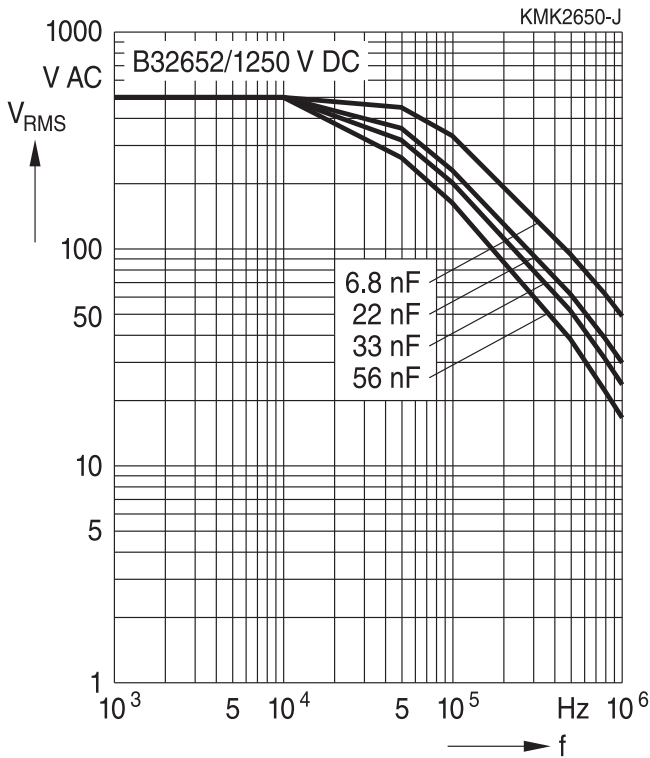

1600 V DC/500 V AC

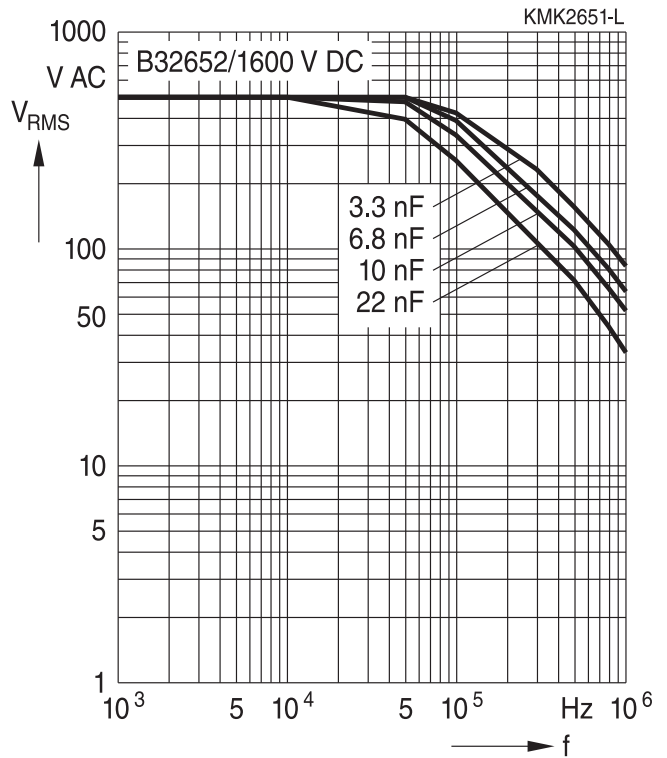

1600 V DC/700 V AC

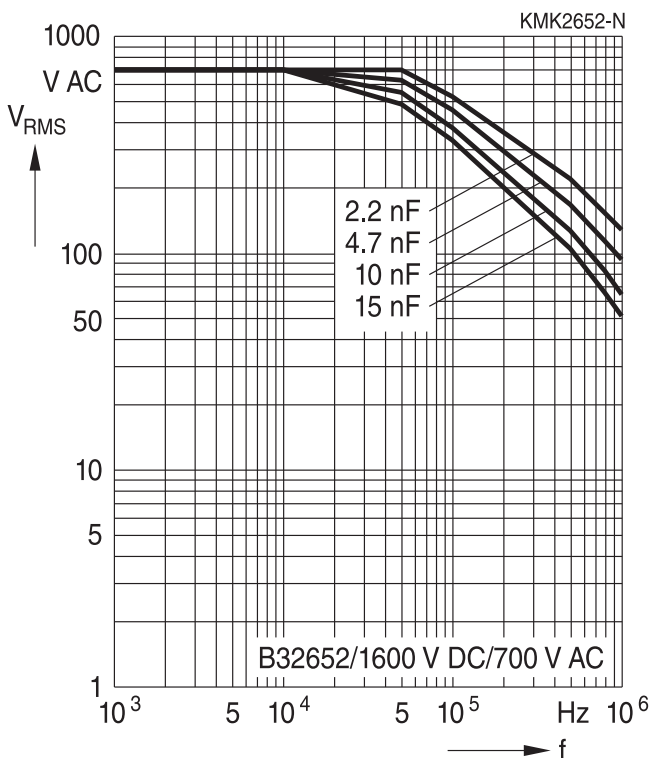

2000 V DC/700 V AC

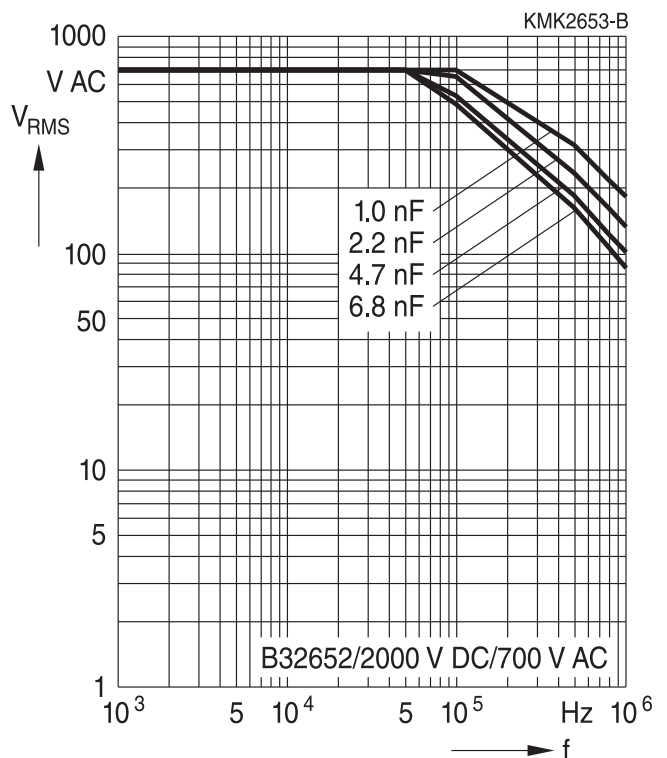

High pulse (wound)

Permissible AC voltage V_{RMS} versus frequency f (for sinusoidal waveforms, ambient temperature $T_A \leq 85^\circ\text{C}$, self-heating $\Delta T \leq 20^\circ\text{C}$ when $\Delta ESR_{typ} \leq \pm 5\%$)
 Lead spacing 22.5 mm

250 V DC/160 V AC

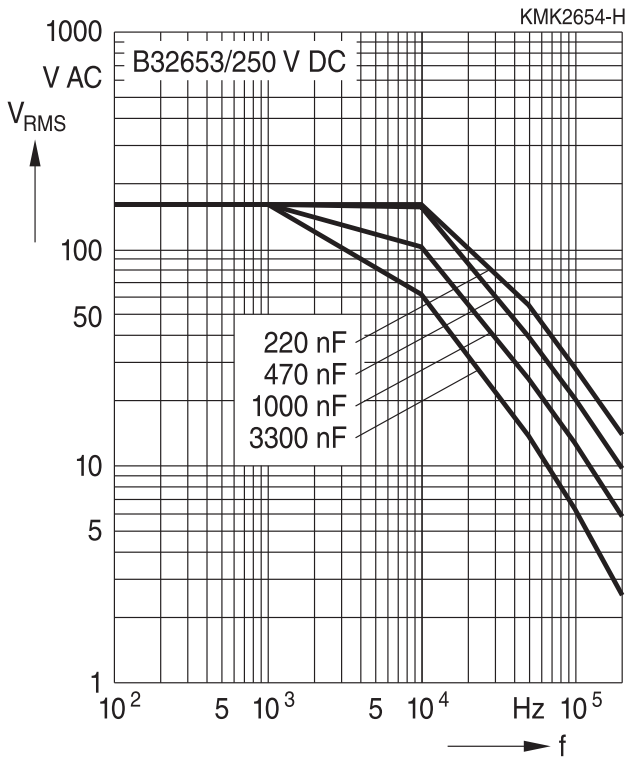

400 V DC/200 V AC

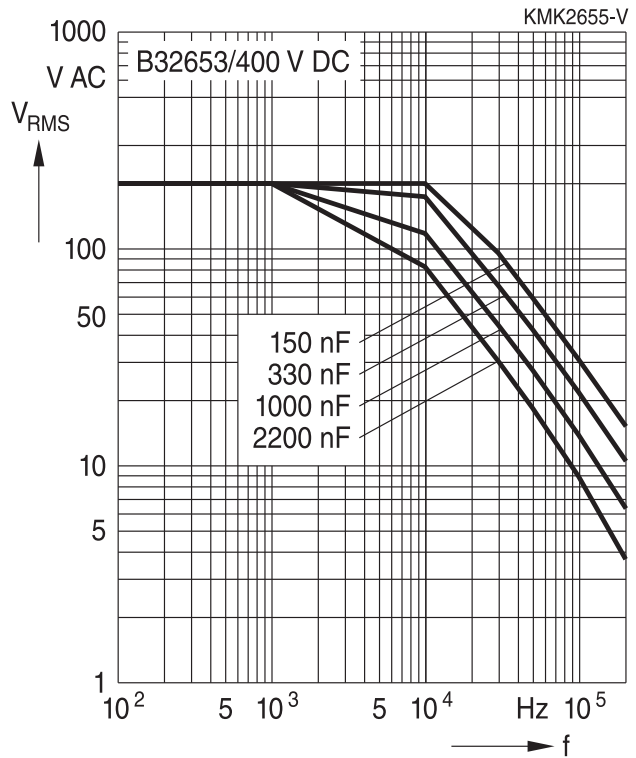

630 V DC/250 V AC

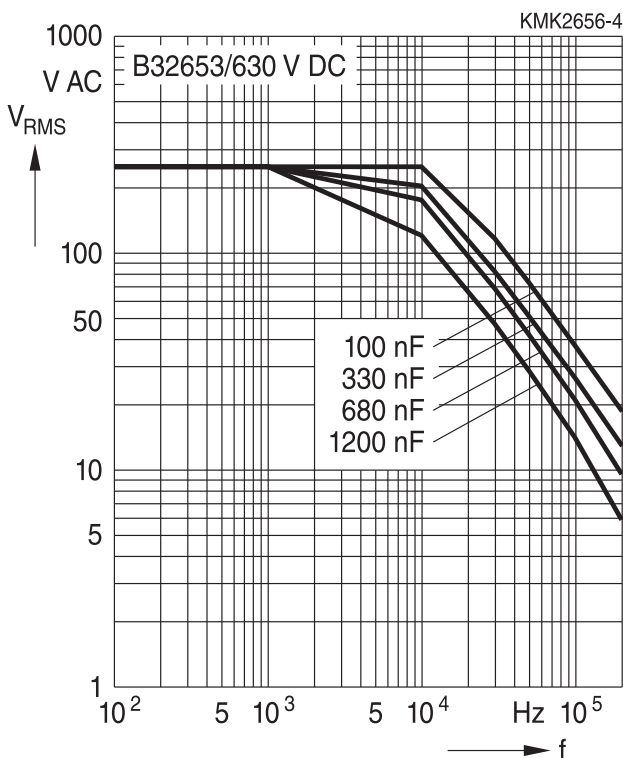

1000 V DC/250 V AC

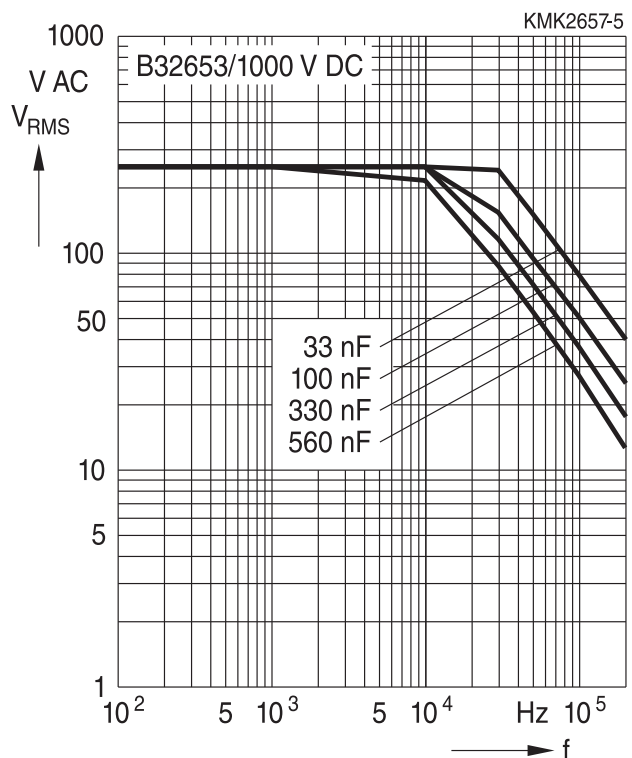

Permissible AC voltage V_{RMS} versus frequency f (for sinusoidal waveforms, ambient temperature $T_A \leq 85^\circ\text{C}$, self-heating $\Delta T \leq 20^\circ\text{C}$ when $\Delta ESR_{typ} \leq \pm 5\%$)
Lead spacing 22.5 mm

1250 V DC/500 V AC

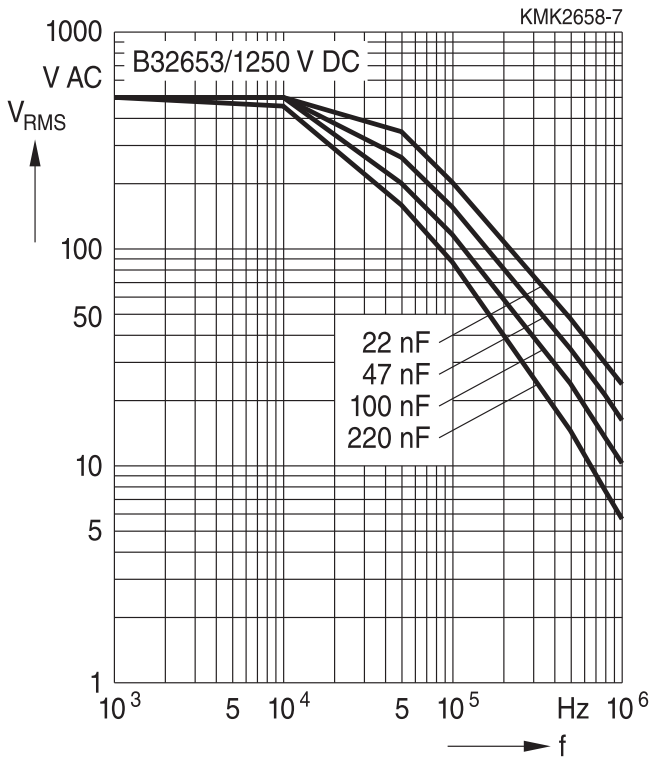

1600 V DC/500 V AC

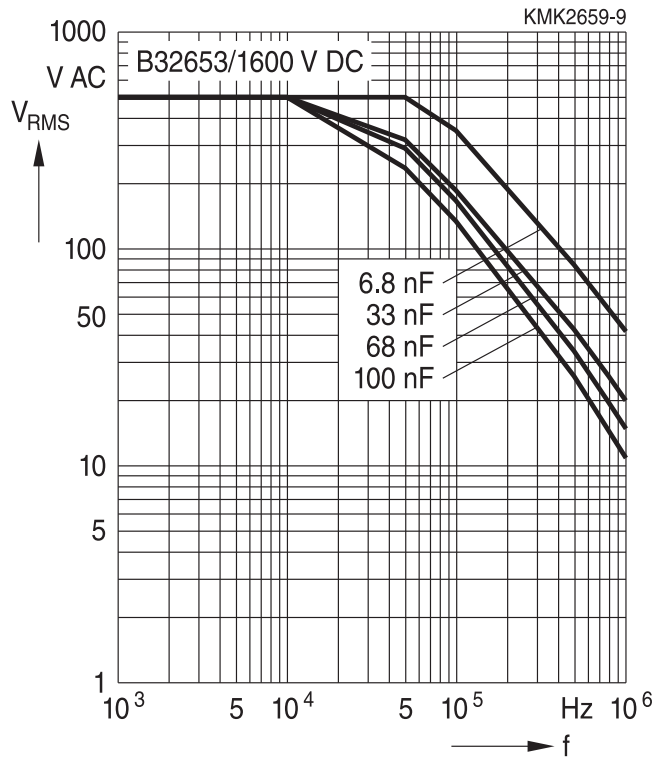

2000 V DC/700 V AC

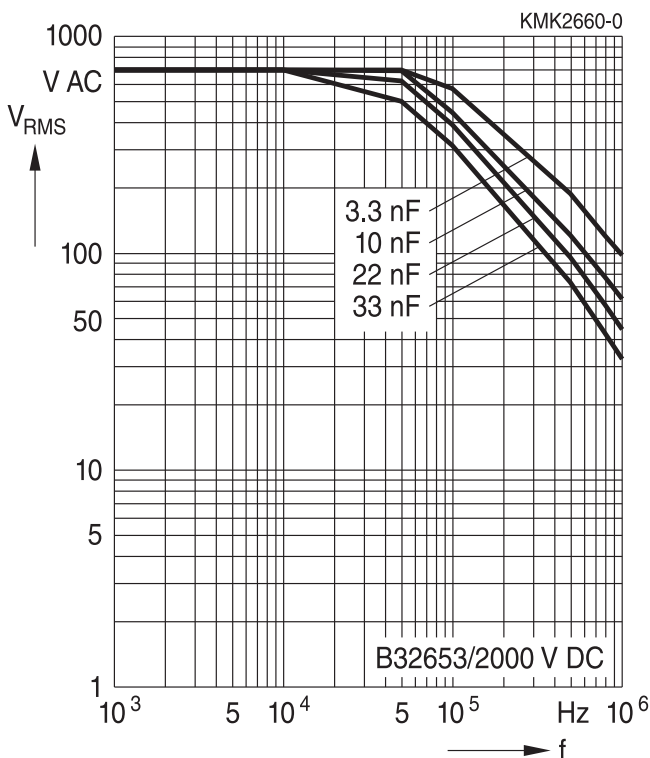

2000 V DC/1000 V AC

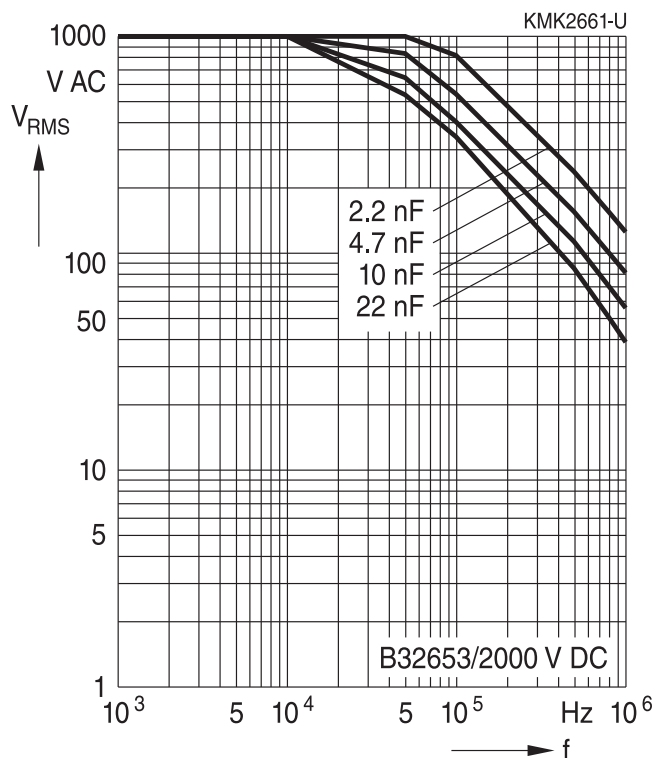

High pulse (wound)

Permissible AC voltage V_{RMS} versus frequency f (for sinusoidal waveforms, ambient temperature $T_A \leq 85\text{ }^\circ\text{C}$, self-heating $\Delta T \leq 20\text{ }^\circ\text{C}$ when $\Delta ESR_{typ} \leq \pm 5\%$)
Lead spacing 27.5 mm

250 V DC/160 V AC

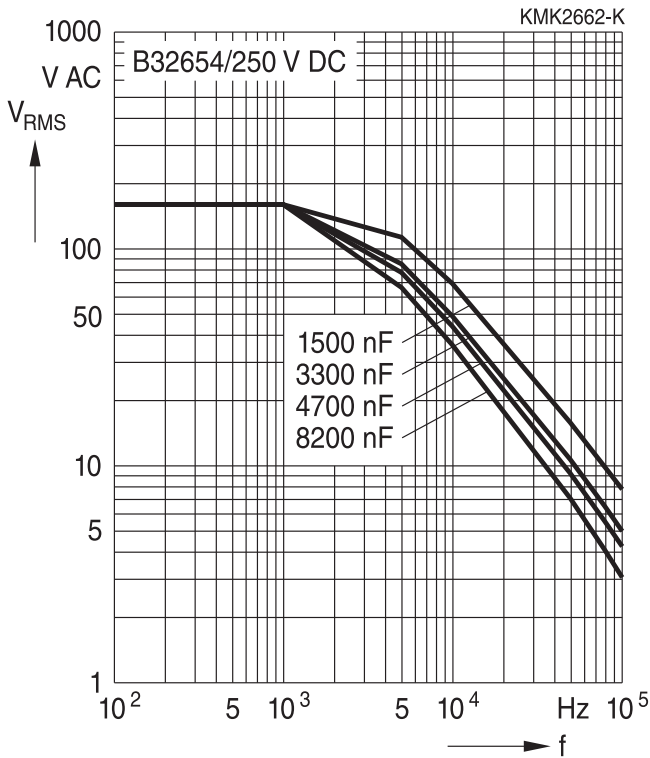

400 V DC/200 V AC

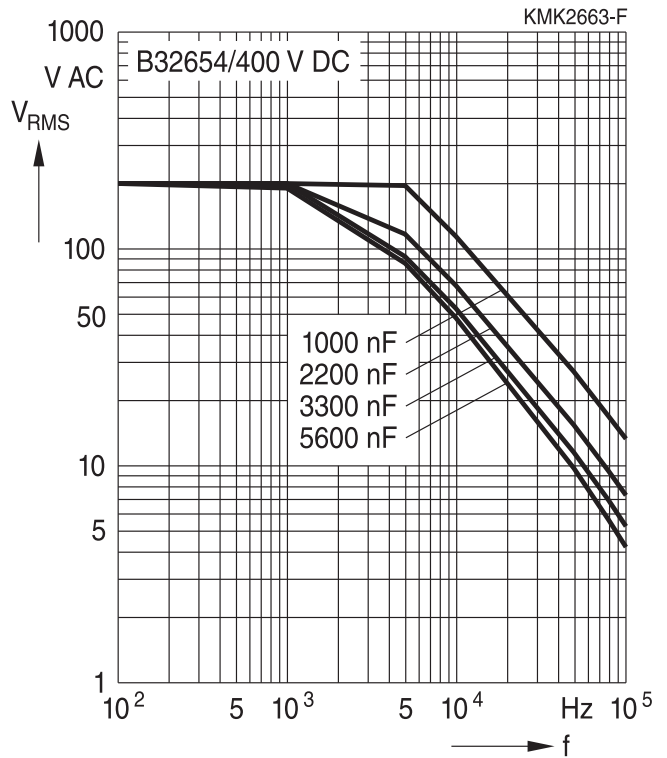

630 V DC/250 V AC

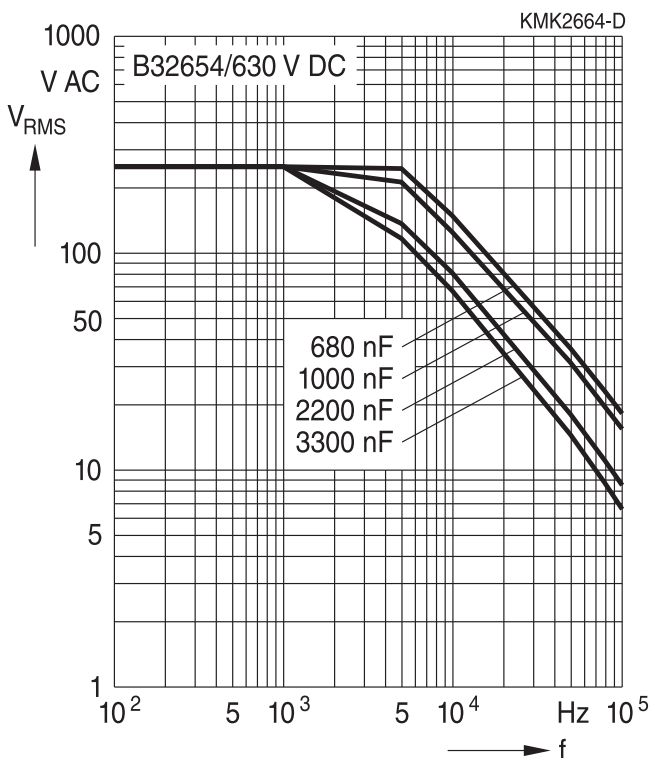

1000 V DC/250 V AC

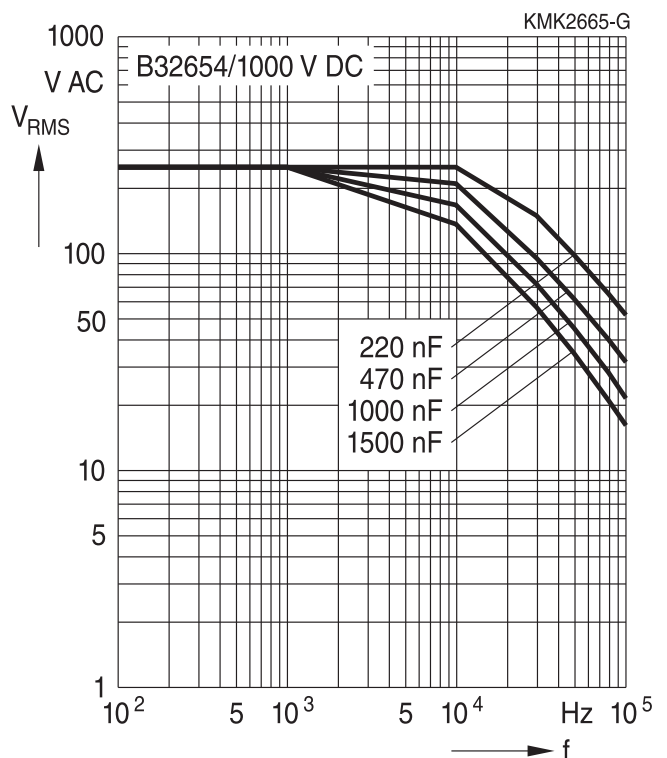

High pulse (wound)

Permissible AC voltage V_{RMS} versus frequency f (for sinusoidal waveforms, ambient temperature $T_A \leq 85^\circ\text{C}$, self-heating $\Delta T \leq 20^\circ\text{C}$ when $\Delta ESR_{typ} \leq \pm 5\%$)
Lead spacing 27.5 mm

1250 V DC/500 V AC

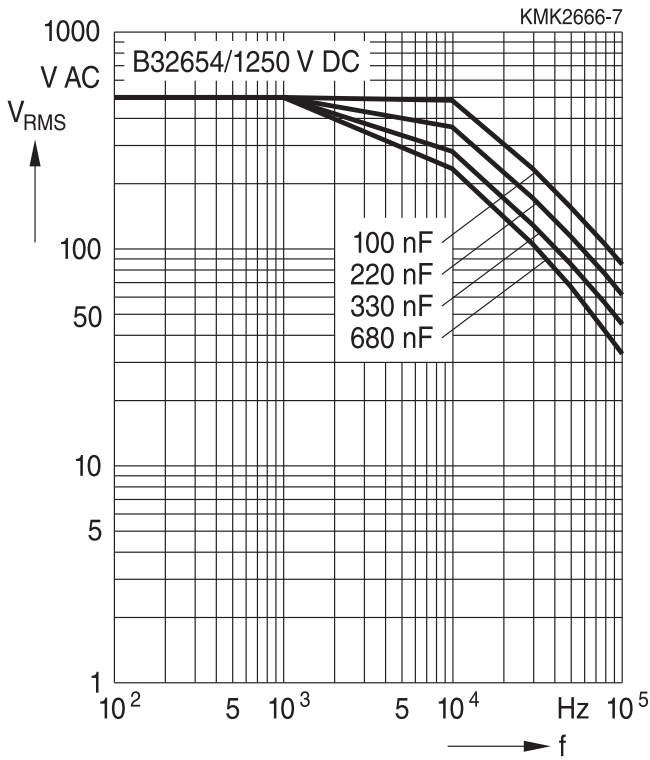

1600 V DC/500 V AC

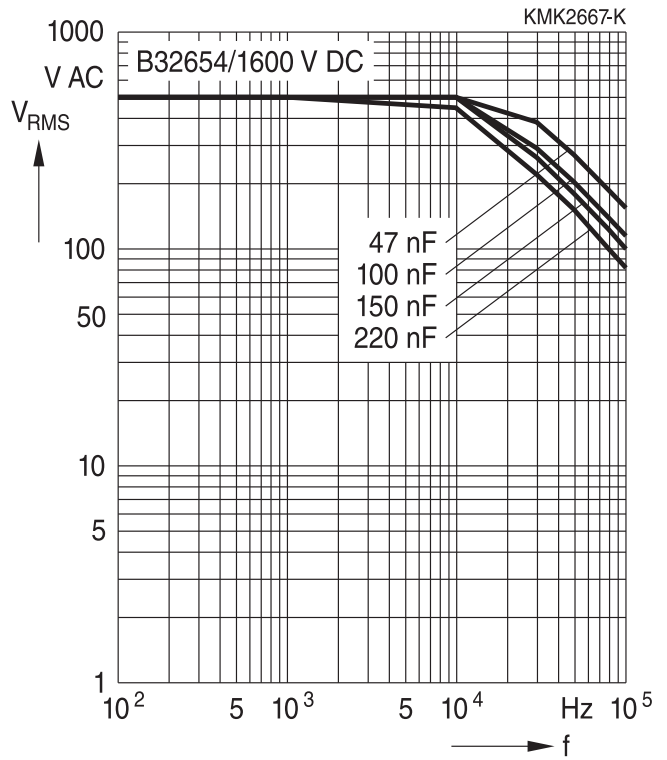

2000 V DC/700 V AC

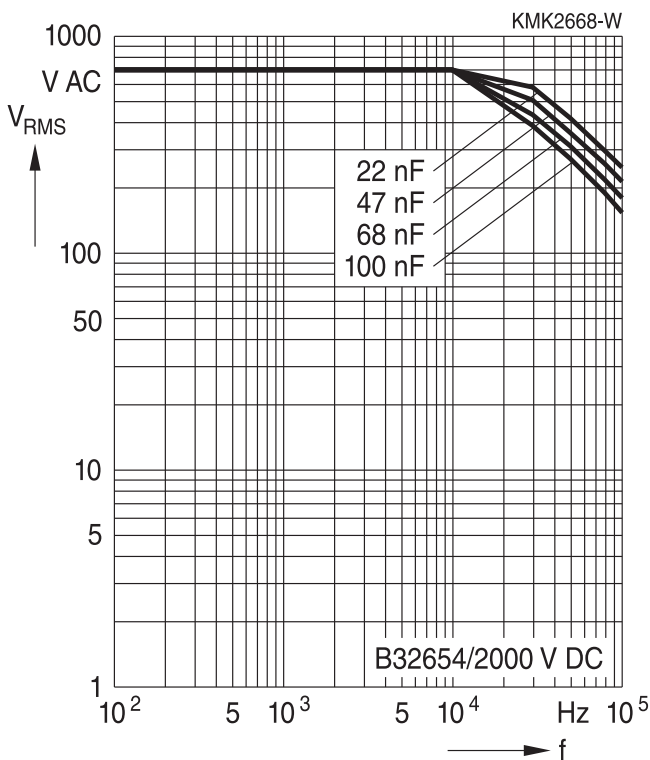

High pulse (wound)

Permissible AC voltage V_{RMS} versus frequency f (for sinusoidal waveforms, ambient temperature $T_A \leq 85^\circ\text{C}$, self-heating $\Delta T \leq 20^\circ\text{C}$ when $\Delta ESR_{typ} \leq \pm 5\%$)
Lead spacing 37.5 mm

250 V DC/160 V AC

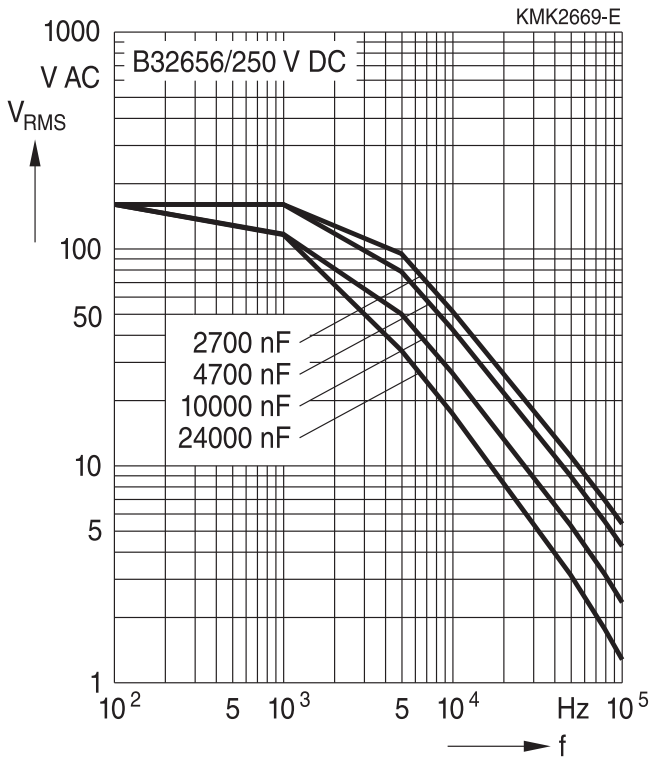

400 V DC/200 V AC

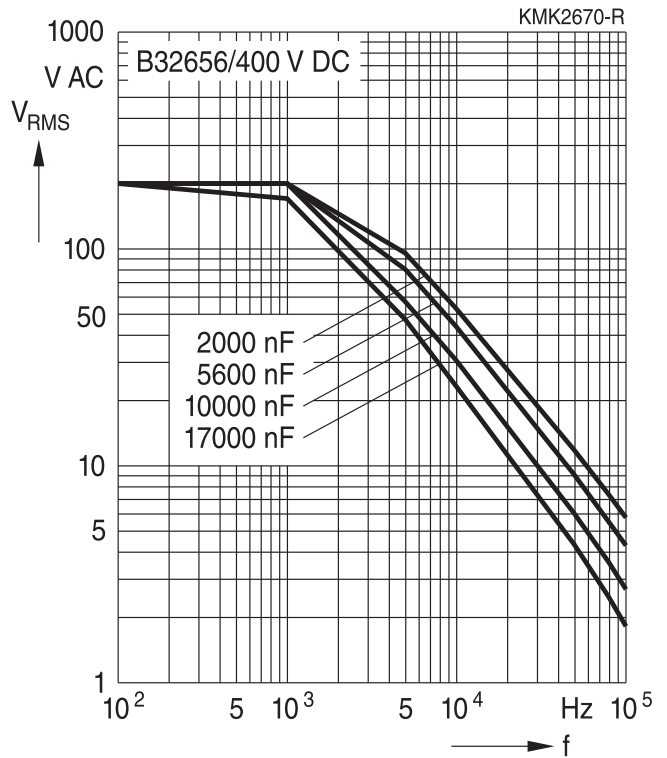

630 V DC/250 V AC

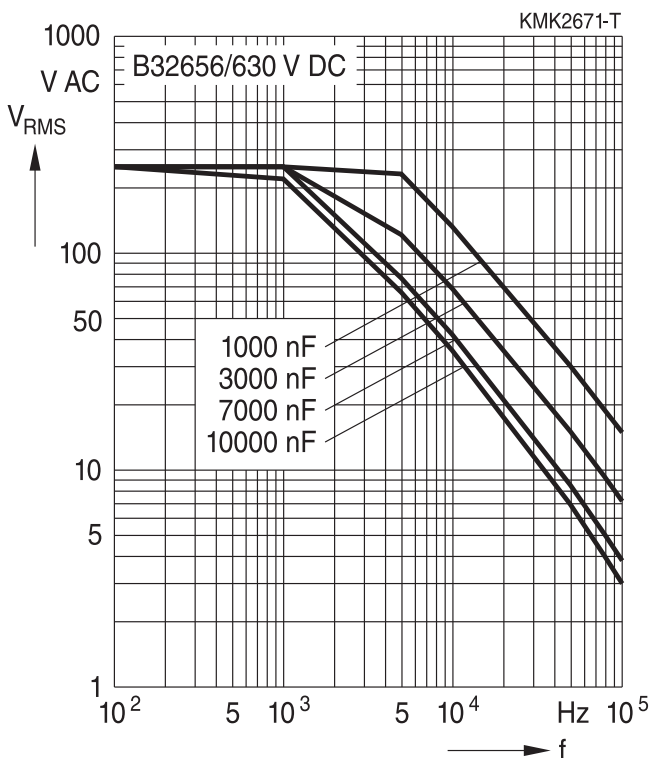

750 V DC/350 V AC

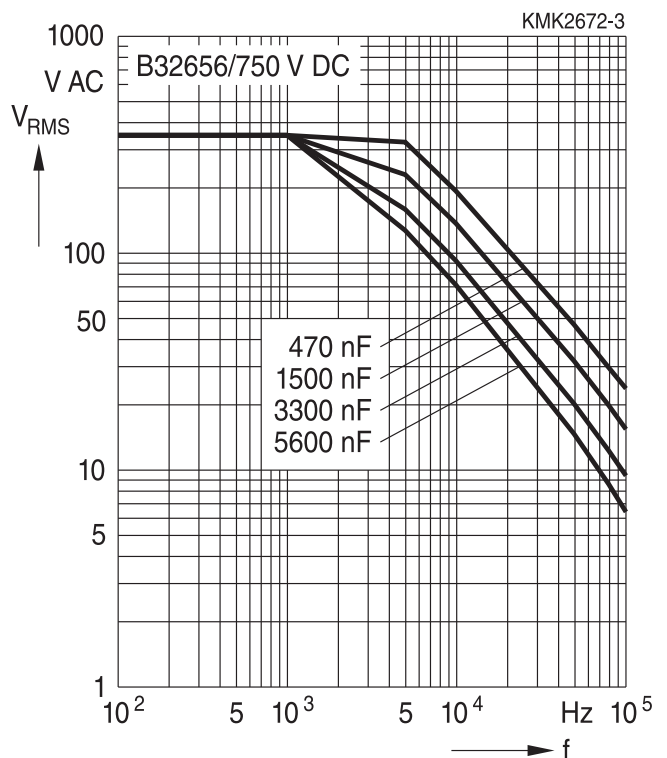

High pulse (wound)

Permissible AC voltage V_{RMS} versus frequency f (for sinusoidal waveforms, ambient temperature $T_A \leq 85^\circ\text{C}$, self-heating $\Delta T \leq 20^\circ\text{C}$ when $\Delta ESR_{typ} \leq \pm 5\%$)
Lead spacing 37.5 mm

850 V DC/450 V AC

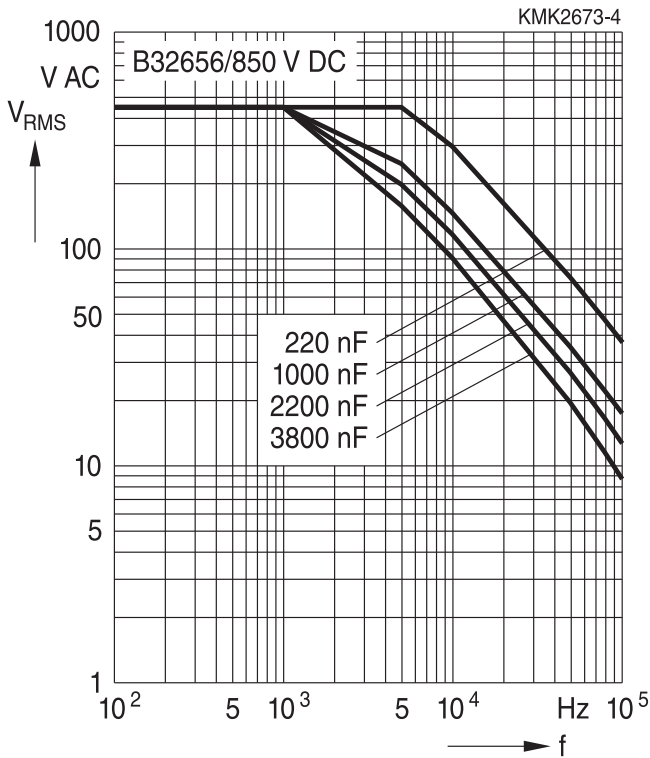

1000 V DC/500 V AC

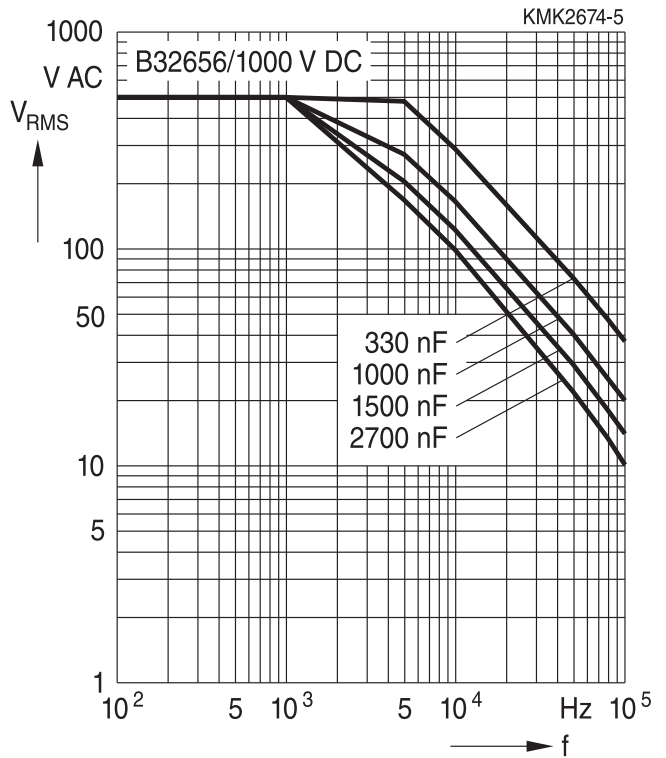

1250 V DC/450 V AC

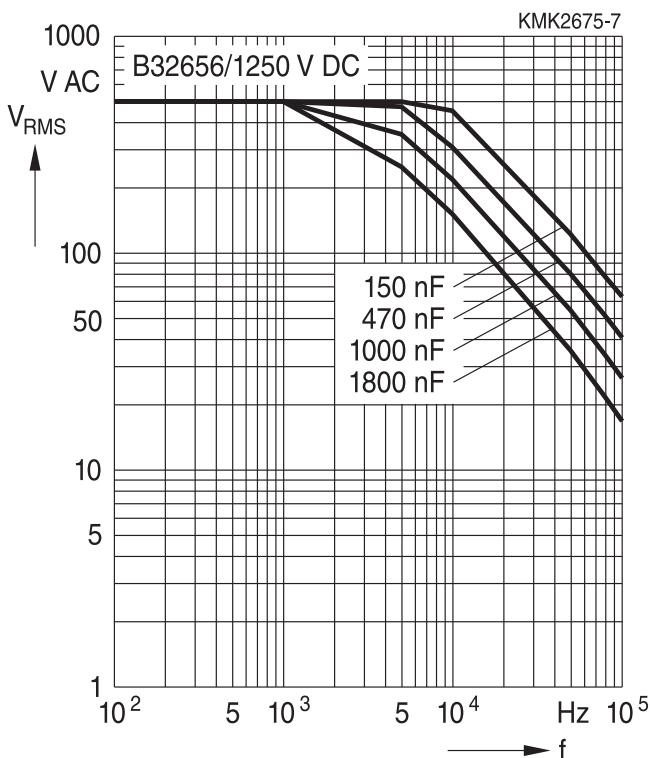

1600 V DC/500 V AC

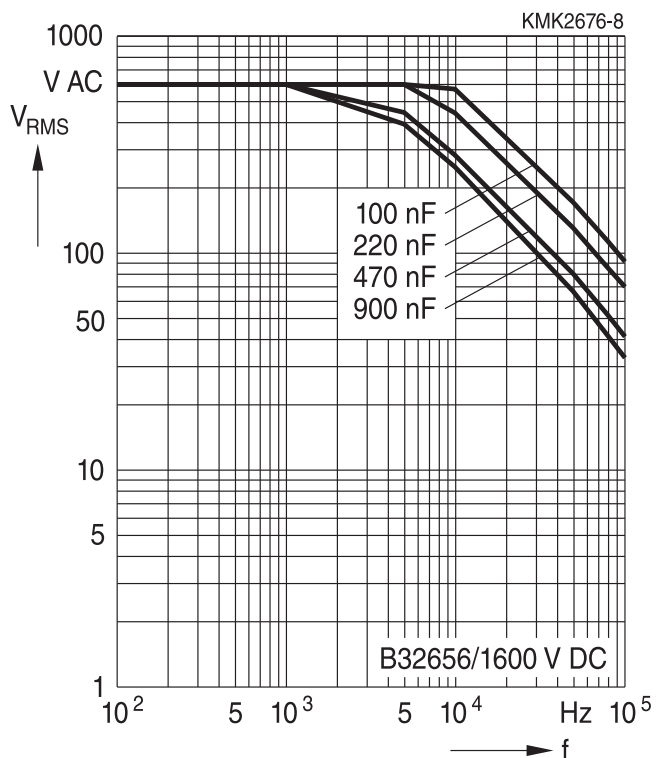

Permissible AC voltage V_{RMS} versus frequency f (for sinusoidal waveforms, ambient temperature $T_A \leq 85\text{ }^\circ\text{C}$, self-heating $\Delta T \leq 20\text{ }^\circ\text{C}$ when $\Delta ESR_{typ} \leq \pm 5\%$)
 Lead spacing 37.5 mm

2000 V DC/700 V AC

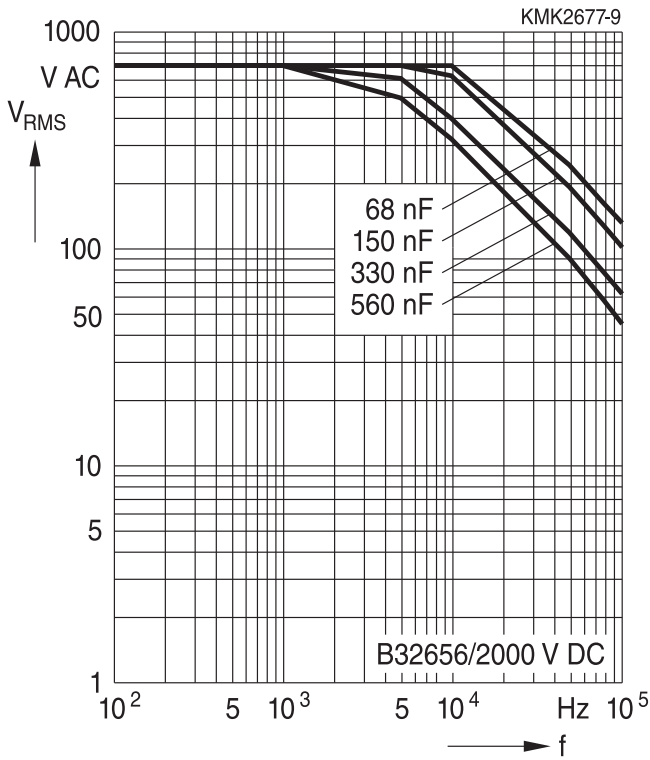

Permissible AC voltage V_{RMS} versus frequency f (for sinusoidal waveforms, ambient temperature $T_A \leq 85^\circ\text{C}$, self-heating $\Delta T \leq 20^\circ\text{C}$ when $\Delta ESR_{typ} \leq \pm 5\%$)
 Lead spacing 52.5 mm

250 V DC/160 V AC

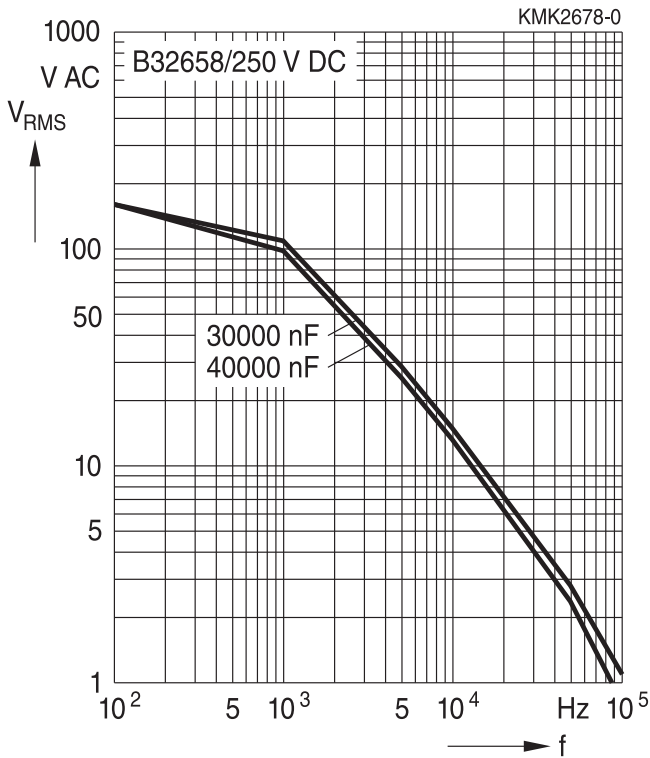

400 V DC/200 V AC

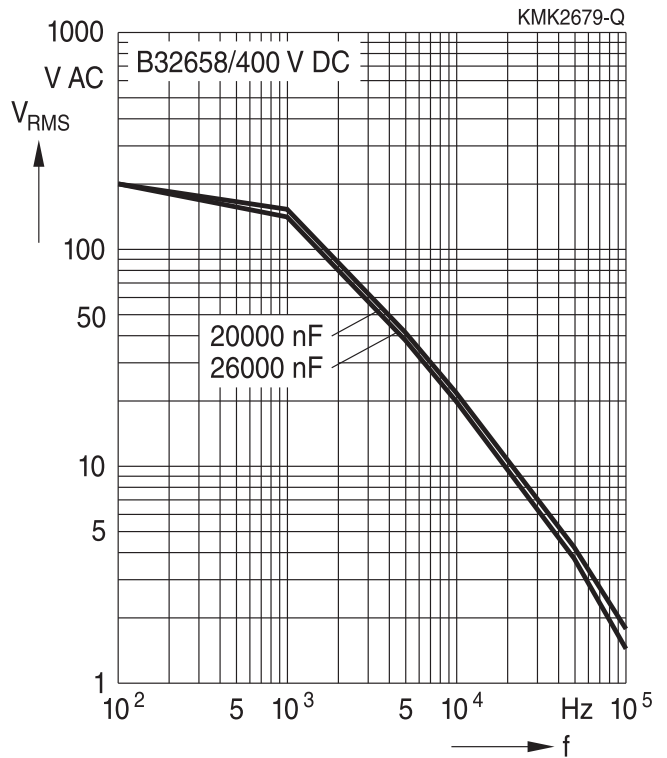

630 V DC/250 V AC

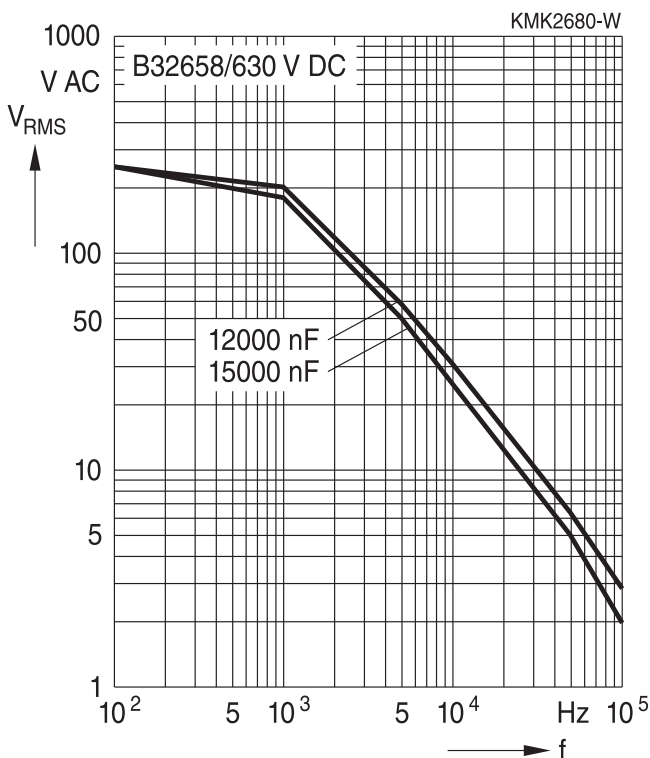

750 V DC/350 V AC

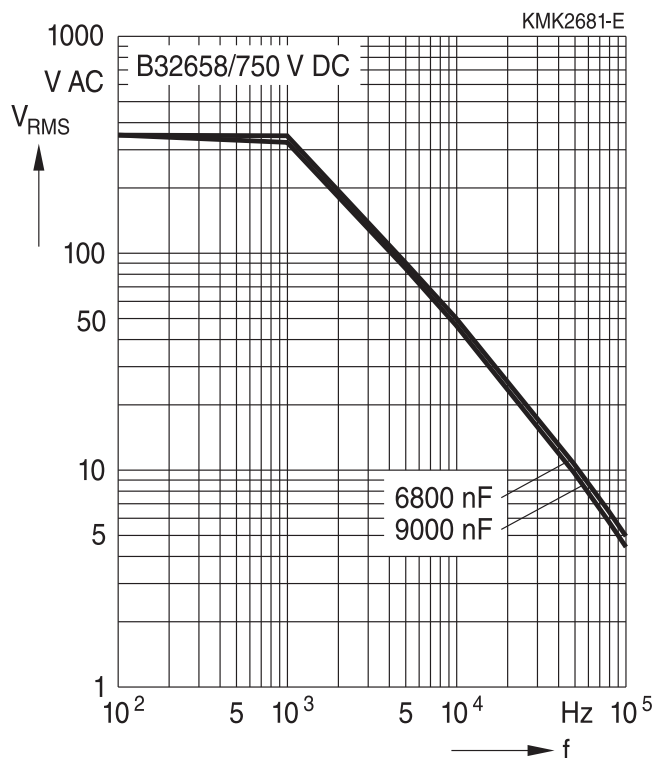

Permissible AC voltage V_{RMS} versus frequency f (for sinusoidal waveforms, ambient temperature $T_A \leq 85^\circ\text{C}$, self-heating $\Delta T \leq 20^\circ\text{C}$ when $\Delta ESR_{typ} \leq \pm 5\%$)
 Lead spacing 52.5 mm

850 V DC/450 V AC

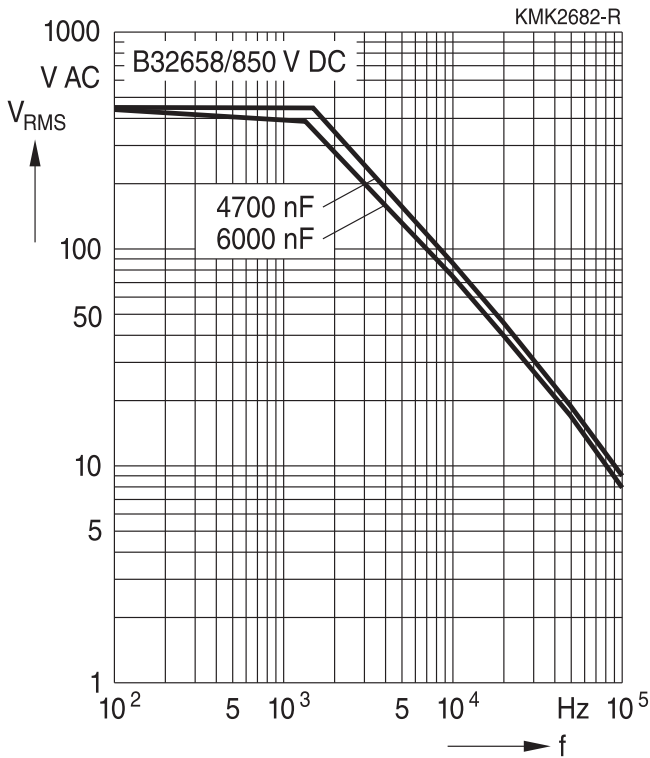

1000 V DC/500 V AC

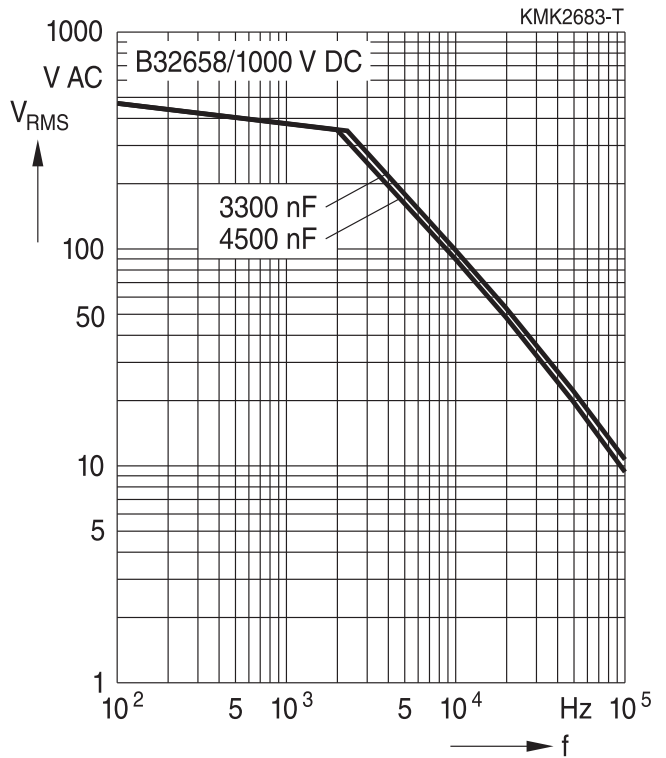

1250 V DC/500 V AC

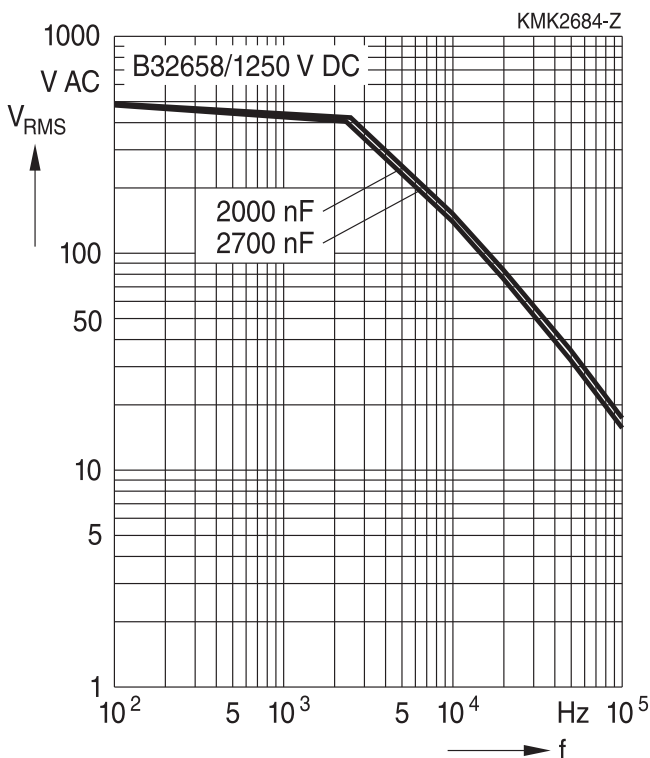

1600 V DC/600 V AC

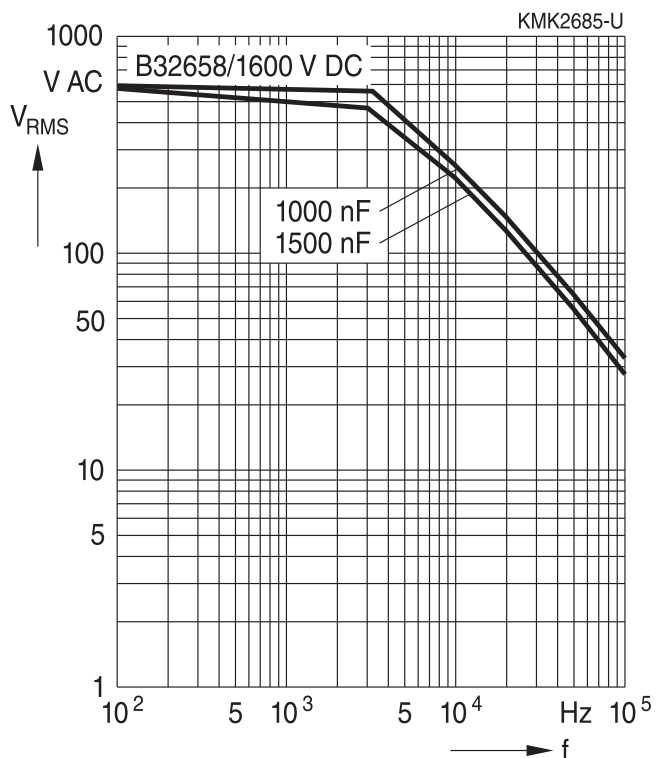

Permissible AC voltage V_{RMS} versus frequency f (for sinusoidal waveforms, ambient temperature $T_A \leq 85\text{ }^\circ\text{C}$, self-heating $\Delta T \leq 20\text{ }^\circ\text{C}$ when $\Delta ESR_{typ} \leq \pm 5\%$)
 Lead spacing 52.5 mm

2000 V DC/700 V AC

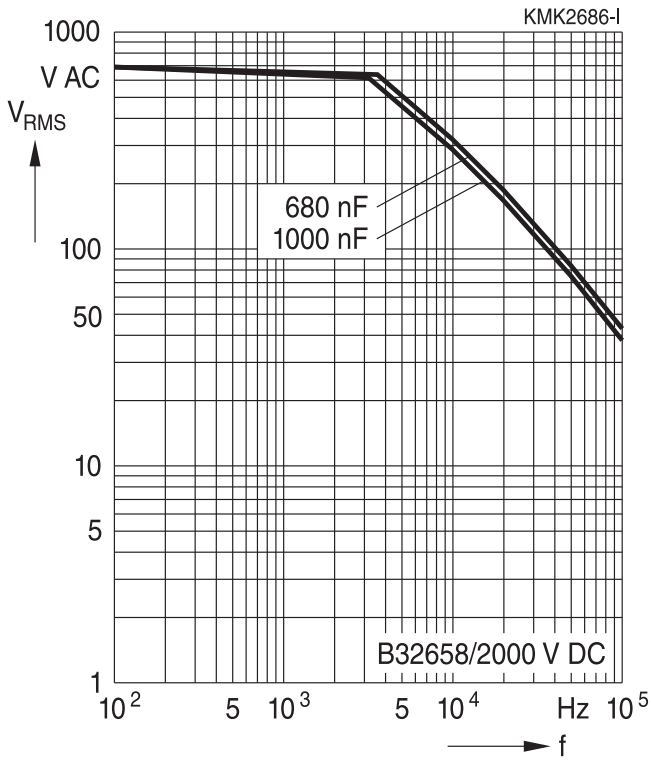

Permissible current I_{RMS} versus frequency f (for sinusoidal waveforms, ambient temperature $T_A \leq 85\text{ }^\circ\text{C}$, self-heating $\Delta T \leq 20\text{ }^\circ\text{C}$ when $\Delta ESR_{typ} \leq \pm 5\%$)
 Lead spacing 10 mm

1250 V DC/450 V AC

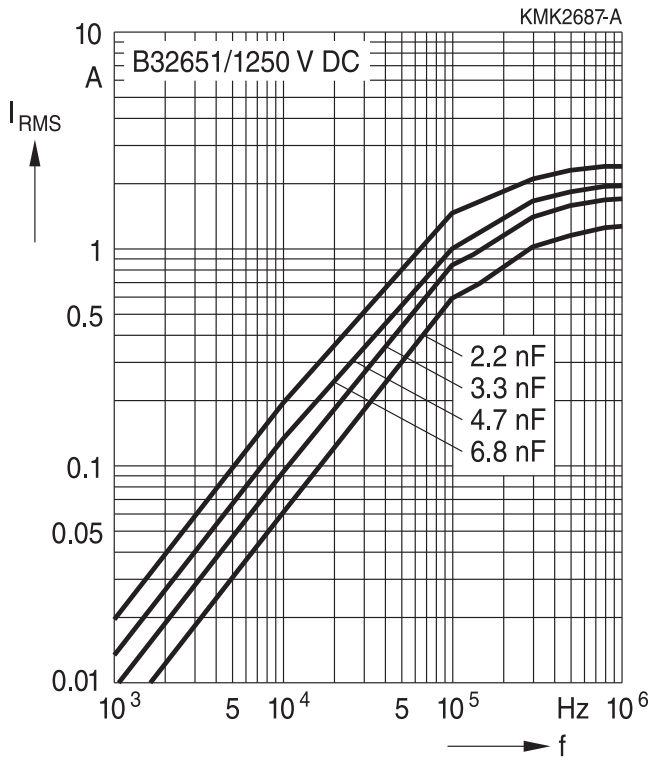

Permissible current I_{RMS} versus frequency f (for sinusoidal waveforms, ambient temperature $T_A \leq 85\text{ }^\circ\text{C}$, self-heating $\Delta T \leq 20\text{ }^\circ\text{C}$ when $\Delta ESR_{typ} \leq \pm 5\%$)
Lead spacing 15 mm

250 V DC/160 V AC

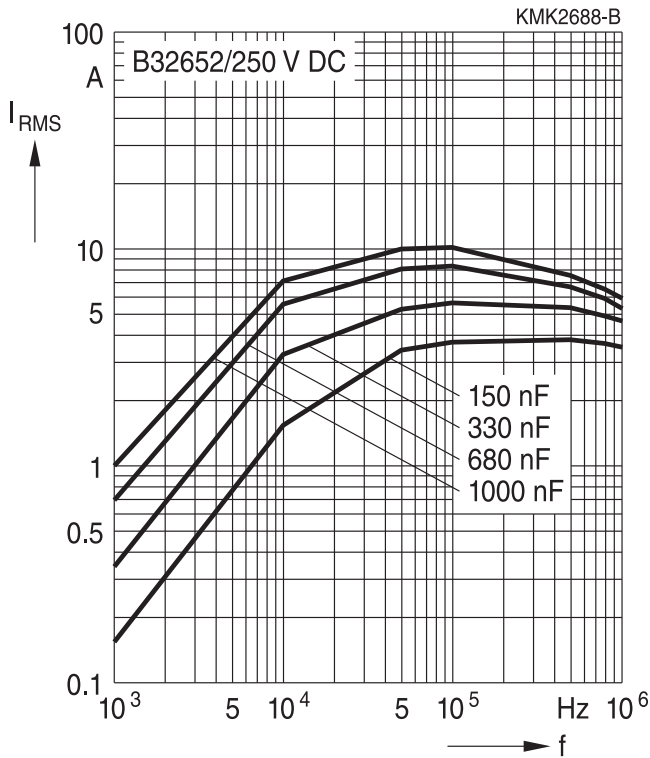

400 V DC/200 V AC

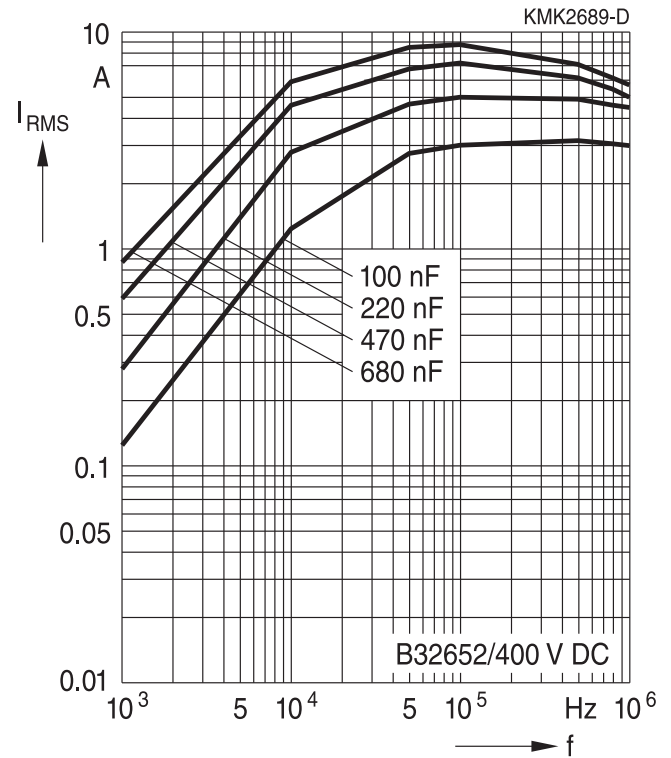

630 V DC/250 V AC

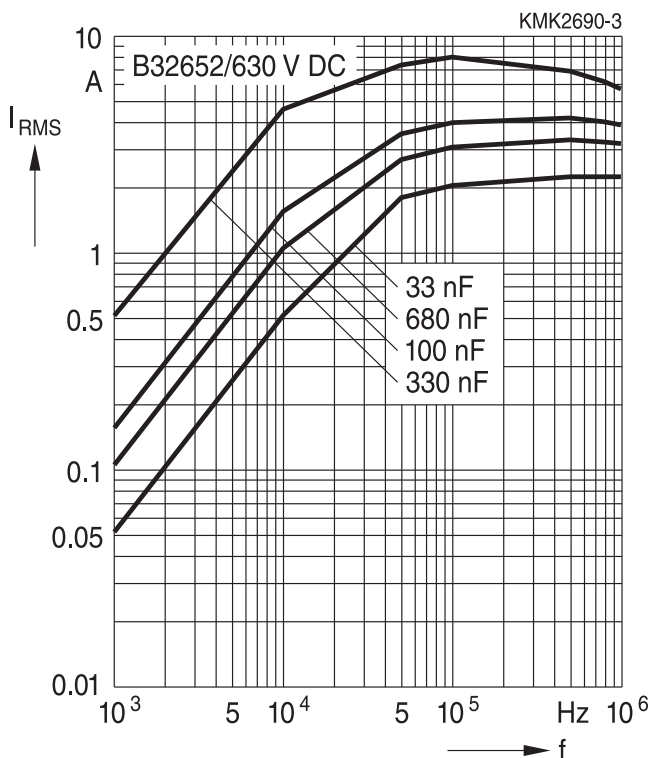

1000 V DC/250 V AC

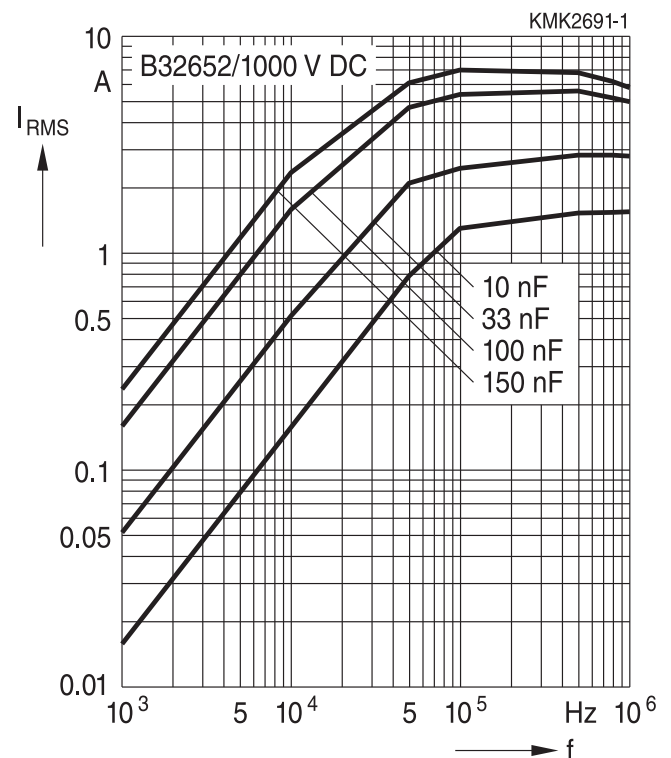

Permissible current I_{RMS} versus frequency f (for sinusoidal waveforms, ambient temperature $T_A \leq 85^\circ C$, self-heating $\Delta T \leq 20^\circ C$ when $\Delta ESR_{typ} \leq \pm 5\%$)
 Lead spacing 15 mm

1250 V DC/500 V AC

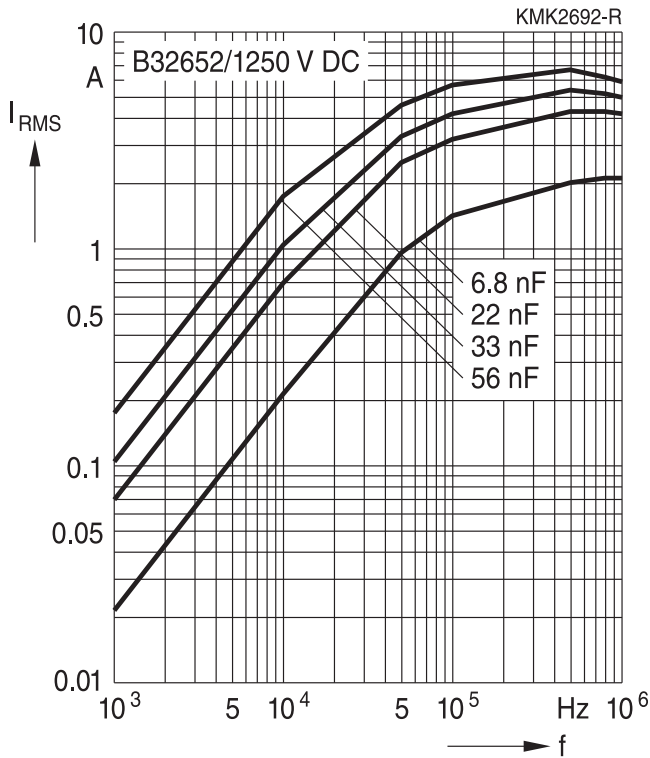

1600 V DC/500 V AC

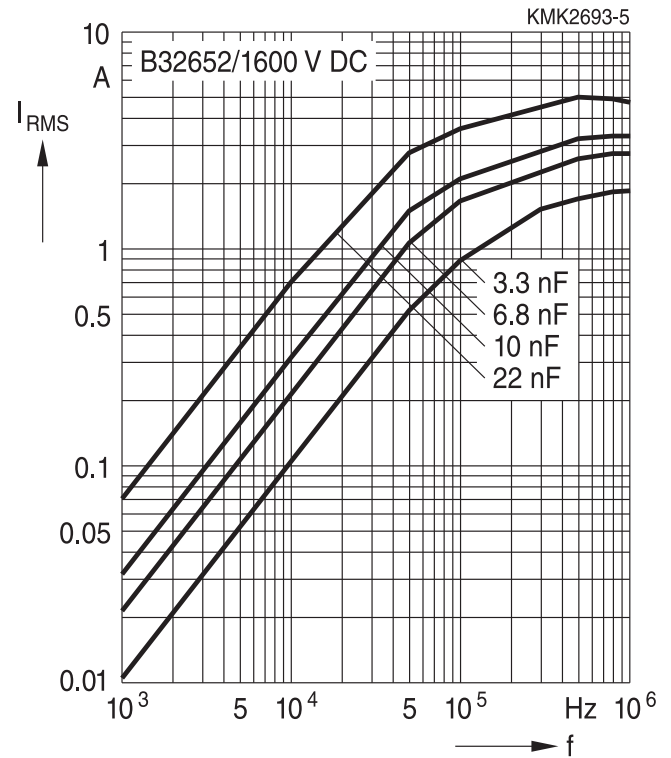

1600 V DC/700 V AC

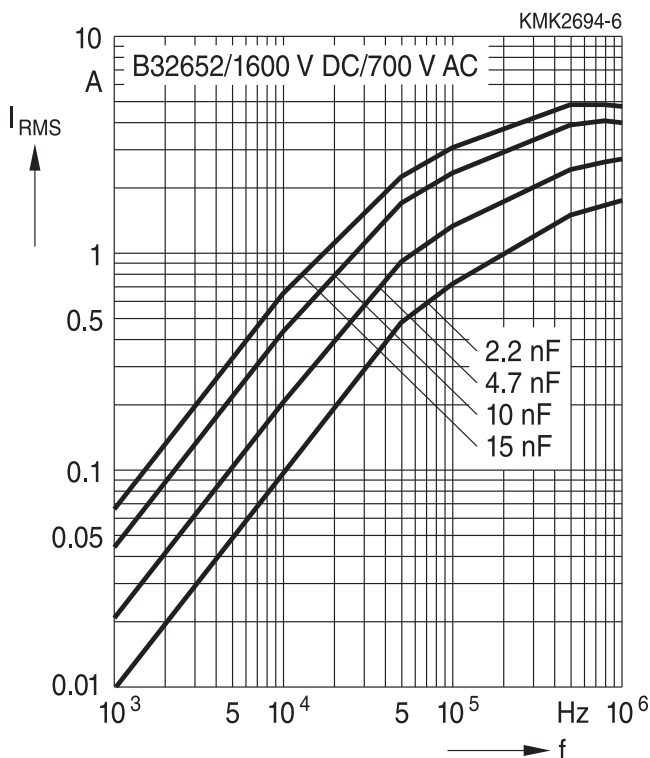

2000 V DC/700 V AC

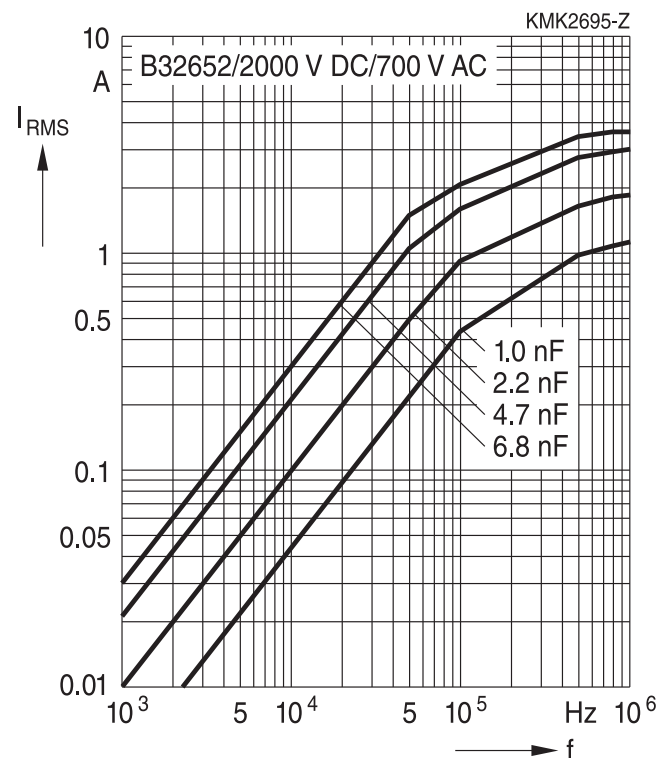

High pulse (wound)

Permissible current I_{RMS} versus frequency f (for sinusoidal waveforms, ambient temperature $T_A \leq 85^\circ\text{C}$, self-heating $\Delta T \leq 20^\circ\text{C}$ when $\Delta ESR_{typ} \leq \pm 5\%$)
 Lead spacing 22.5 mm

250 V DC/160 V AC

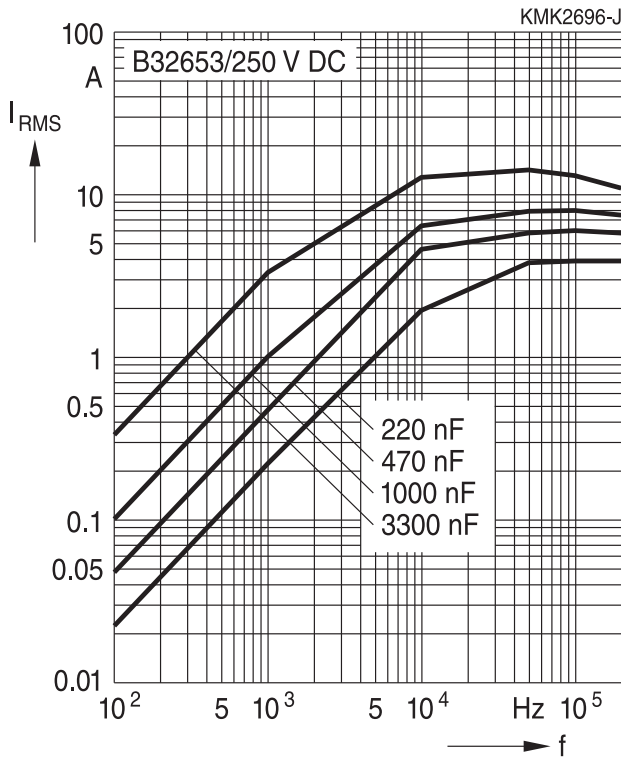

400 V DC/200 V AC

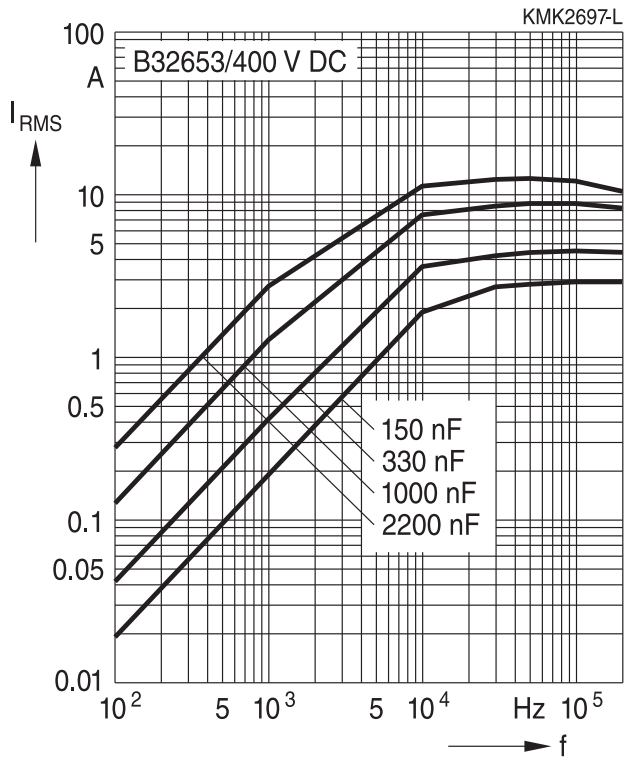

630 V DC/250 V AC

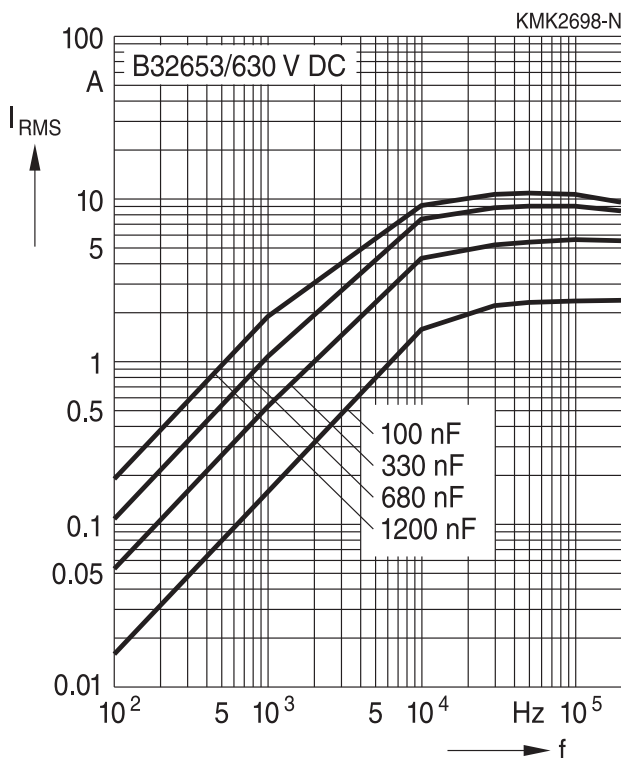

1000 V DC/250 V AC

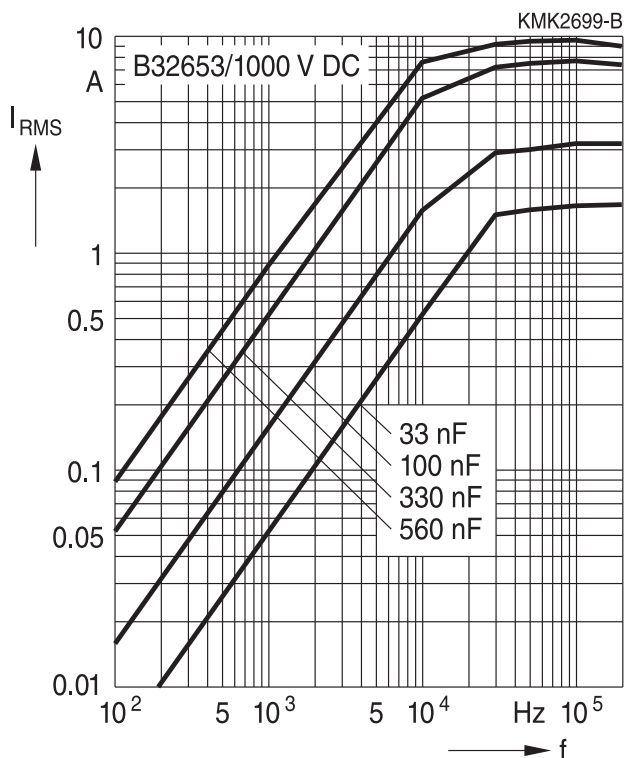

Permissible current I_{RMS} versus frequency f (for sinusoidal waveforms, ambient temperature $T_A \leq 85^\circ C$, self-heating $\Delta T \leq 20^\circ C$ when $\Delta ESR_{typ} \leq \pm 5\%$)
Lead spacing 22.5 mm

1250 V DC/500 V AC

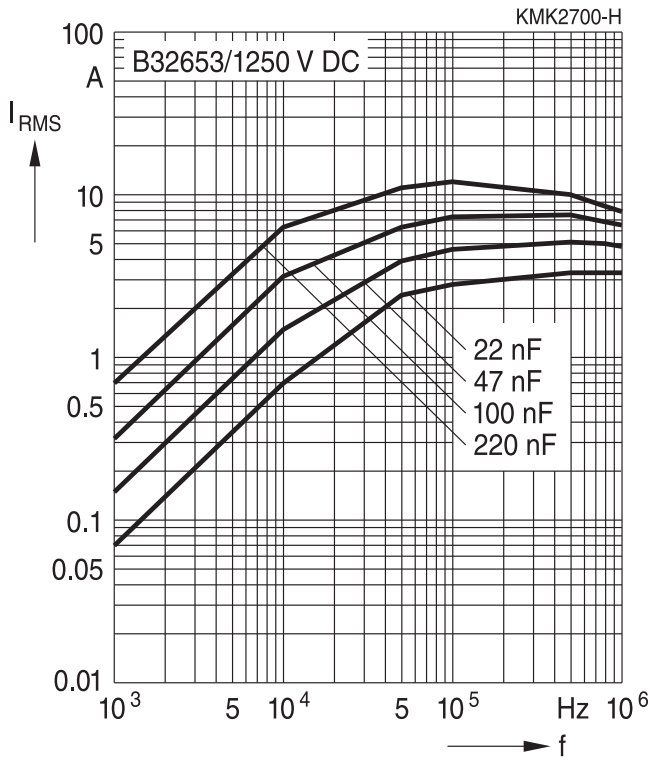

1600 V DC/500 V AC

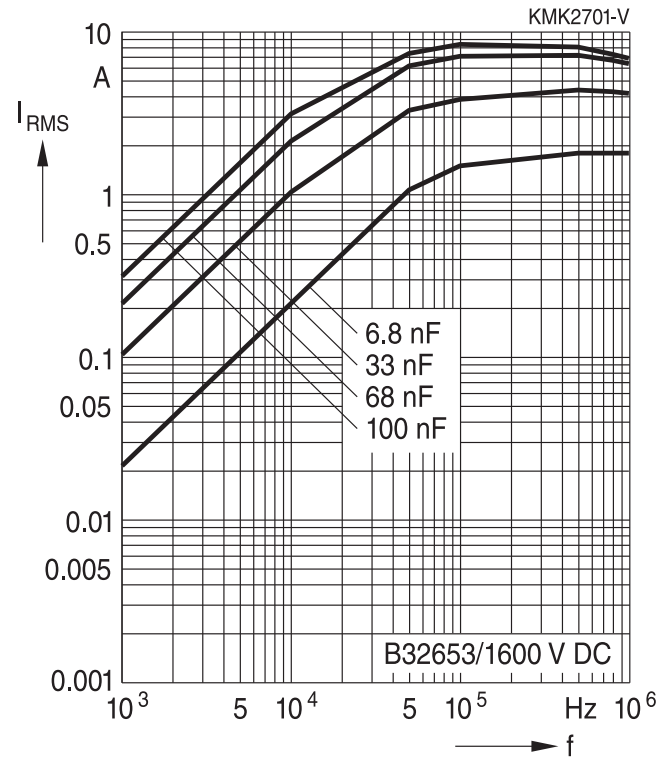

2000 V DC/700 V AC

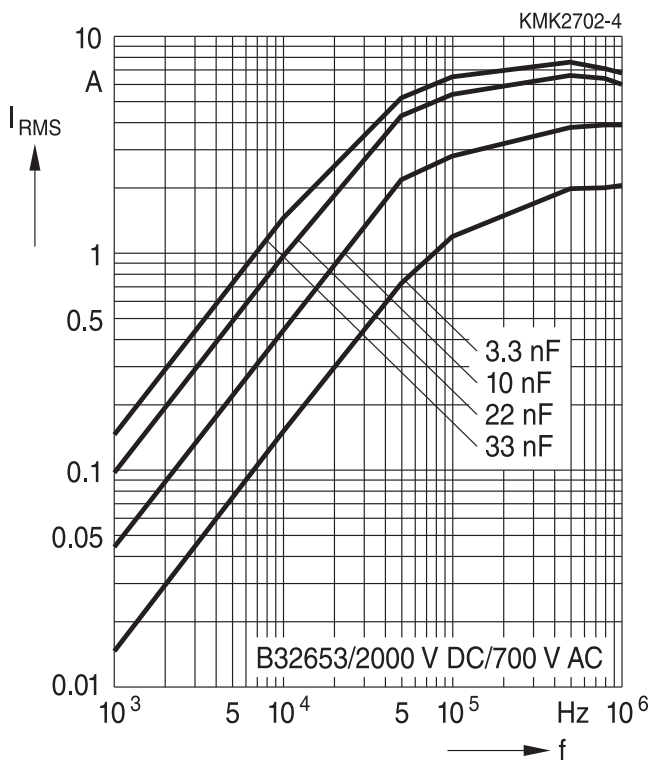

2000 V DC/1000 V AC

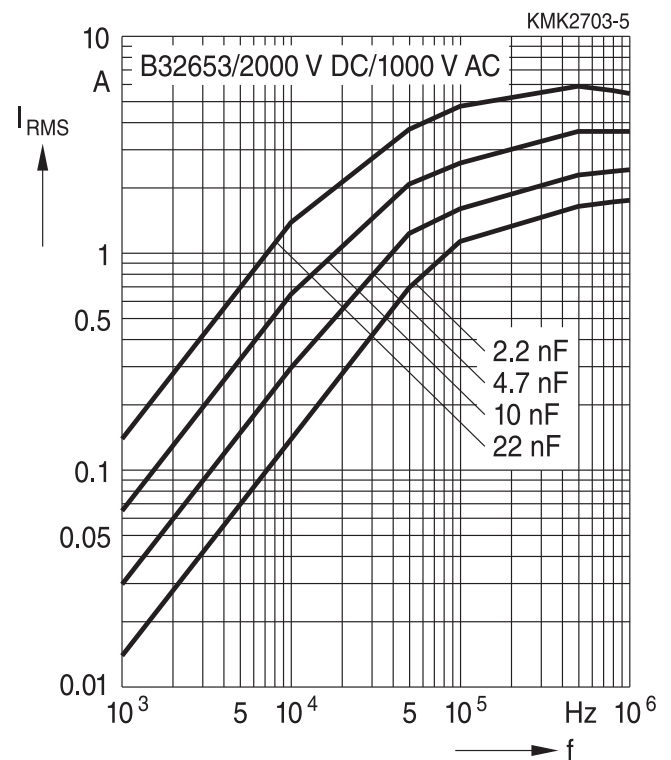

Permissible current I_{RMS} versus frequency f (for sinusoidal waveforms, ambient temperature $T_A \leq 85^\circ\text{C}$, self-heating $\Delta T \leq 20^\circ\text{C}$ when $\Delta ESR_{typ} \leq \pm 5\%$)
 Lead spacing 27.5 mm

250 V DC/160 V AC

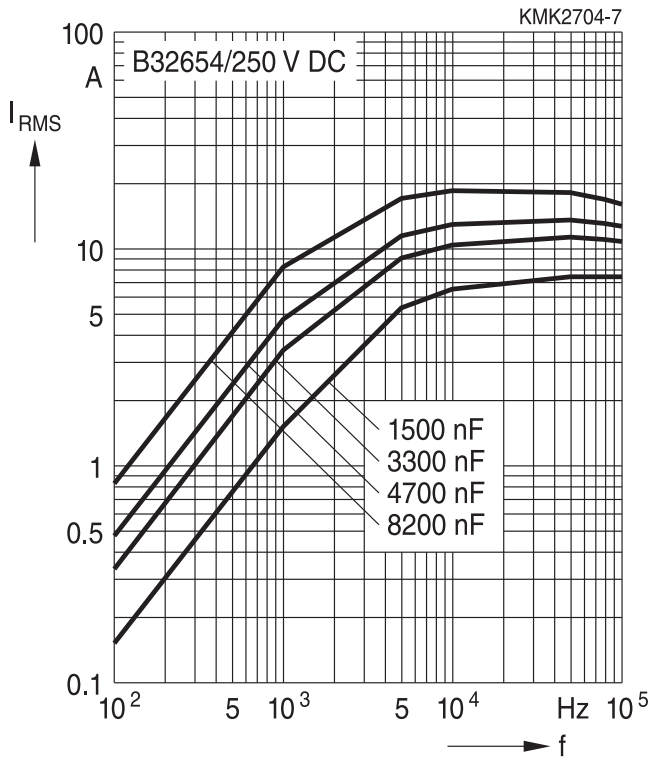

400 V DC/200 V AC

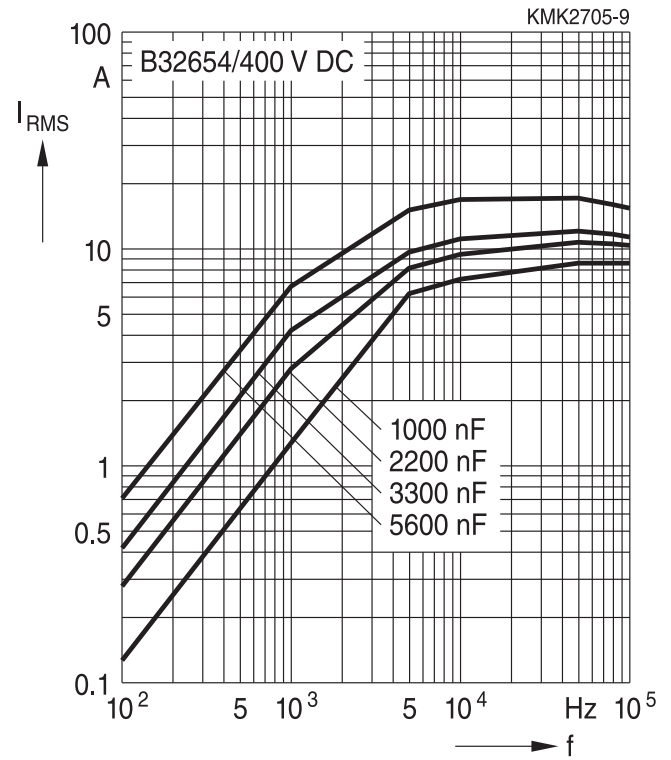

630 V DC/250 V AC

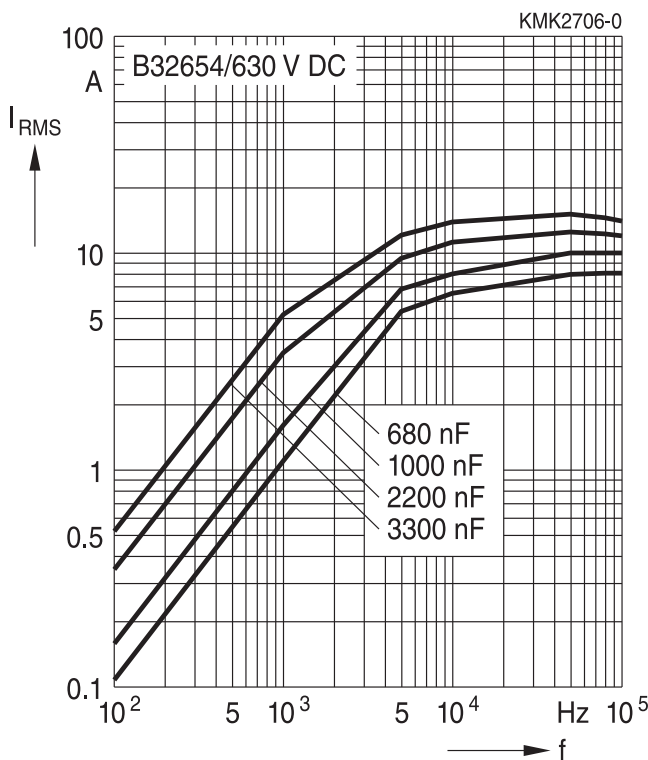

1000 V DC/250 V AC

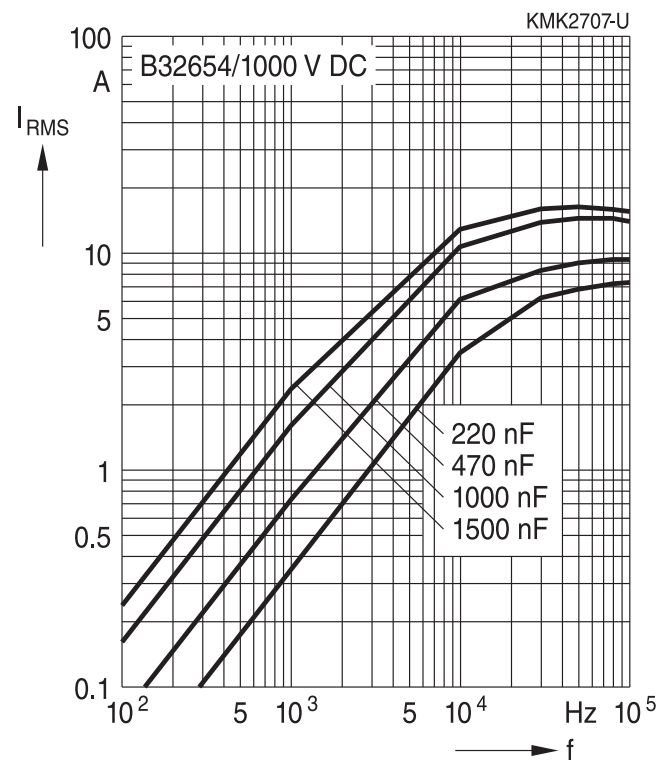

Permissible current I_{RMS} versus frequency f (for sinusoidal waveforms, ambient temperature $T_A \leq 85^\circ\text{C}$, self-heating $\Delta T \leq 20^\circ\text{C}$ when $\Delta ESR_{typ} \leq \pm 5\%$)
Lead spacing 27.5 mm

1250 V DC/500 V AC

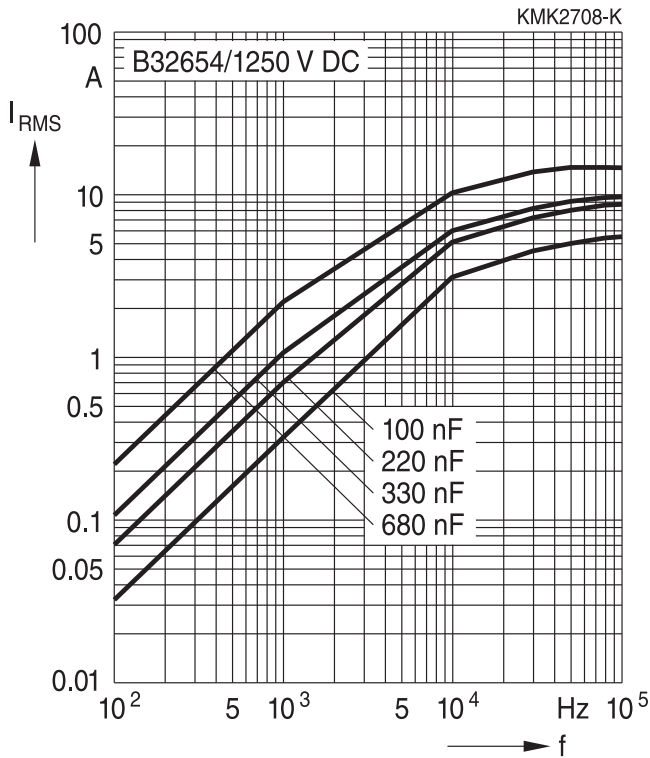

1600 V DC/500 V AC

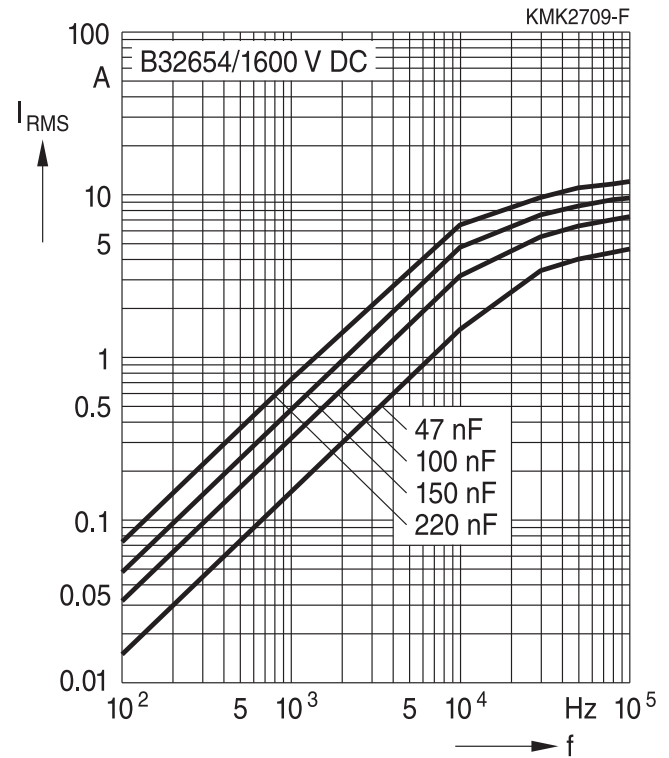

2000 V DC/700 V AC

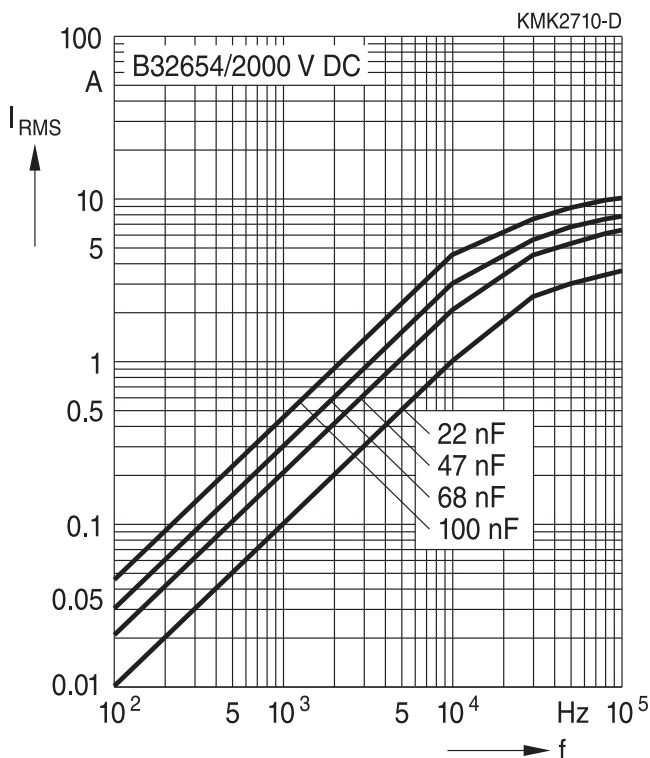

Permissible current I_{RMS} versus frequency f (for sinusoidal waveforms, ambient temperature $T_A \leq 85^\circ\text{C}$, self-heating $\Delta T \leq 20^\circ\text{C}$ when $\Delta ESR_{typ} \leq \pm 5\%$)
 Lead spacing 37.5 mm

250 V DC/160 V AC

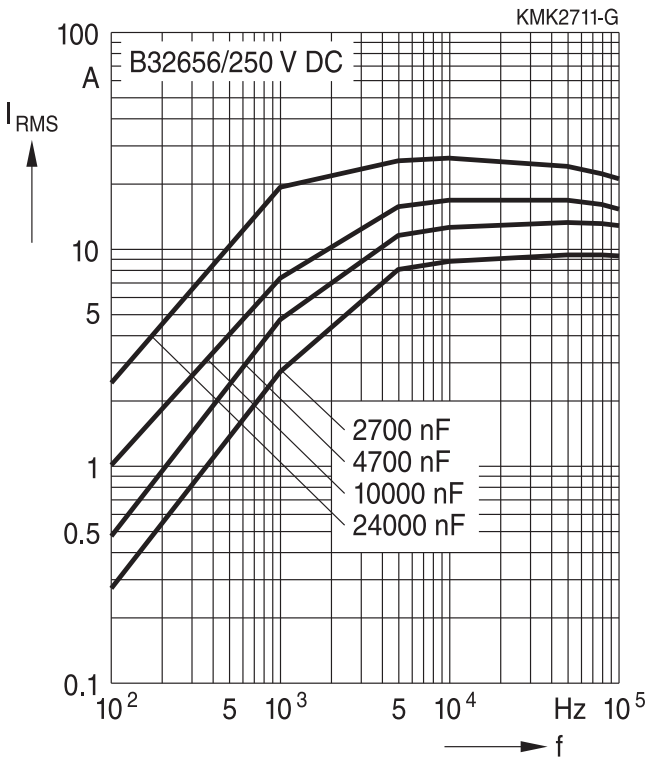

400 V DC/200 V AC

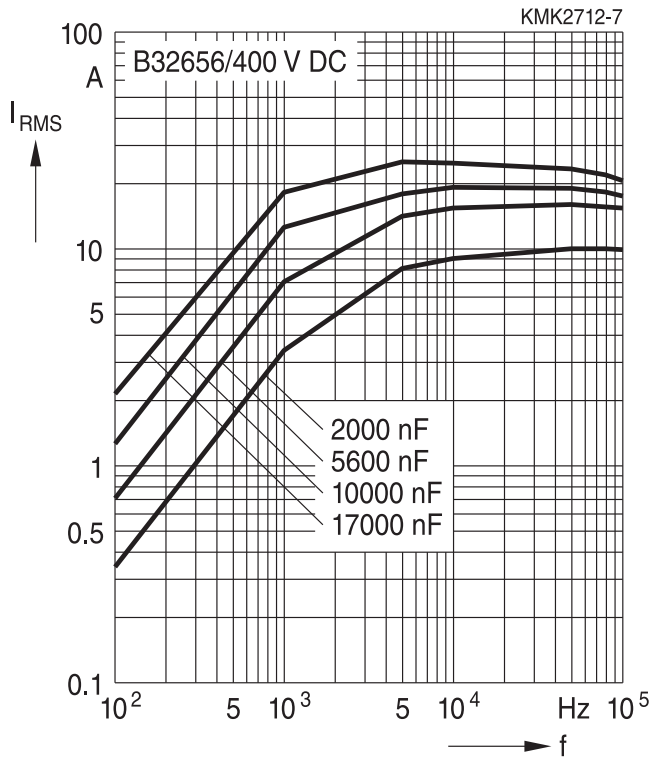

630 V DC/250 V AC

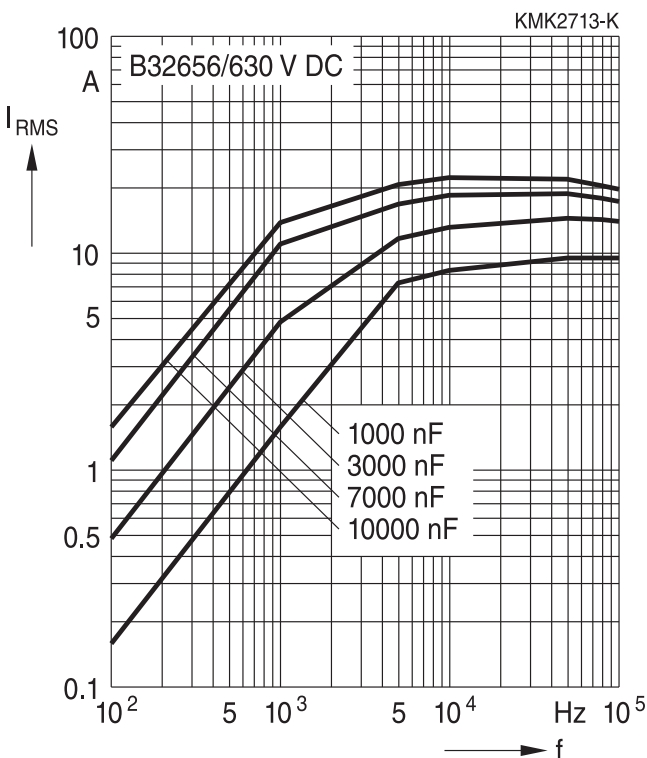

750 V DC/350 V AC

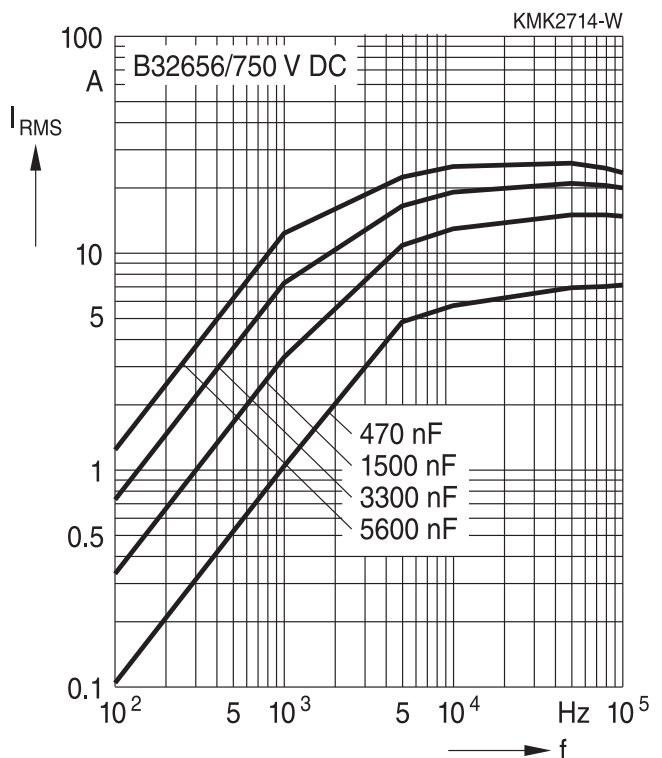

High pulse (wound)

Permissible current I_{RMS} versus frequency f (for sinusoidal waveforms, ambient temperature $T_A \leq 85^\circ\text{C}$, self-heating $\Delta T \leq 20^\circ\text{C}$ when $\Delta ESR_{typ} \leq \pm 5\%$)
Lead spacing 37.5 mm

850 V DC/450 V AC

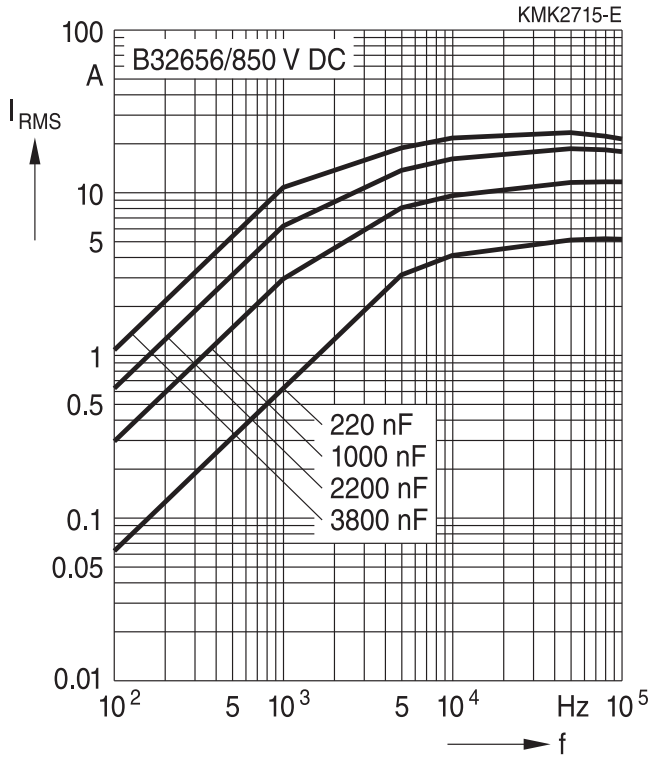

1000 V DC/500 V AC

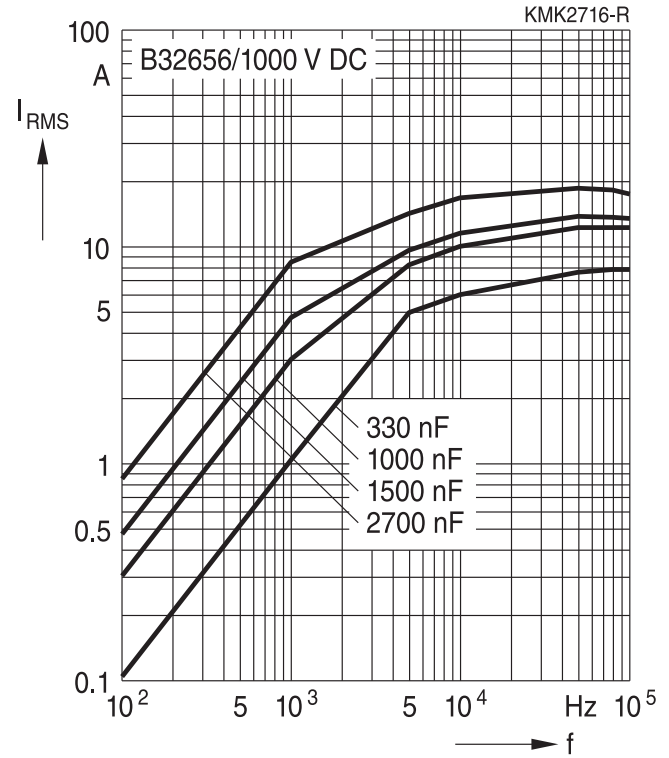

1250 V DC/500 V AC

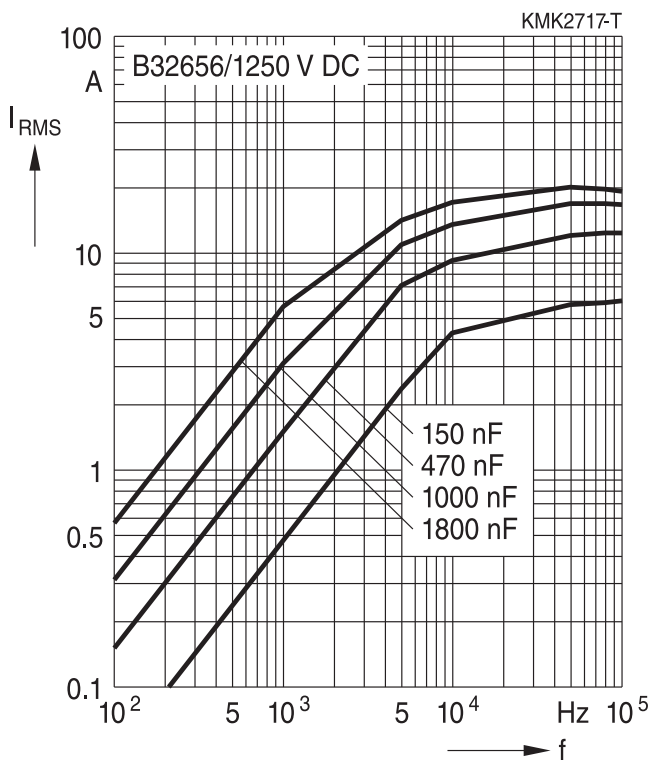

1600 V DC/600 V AC

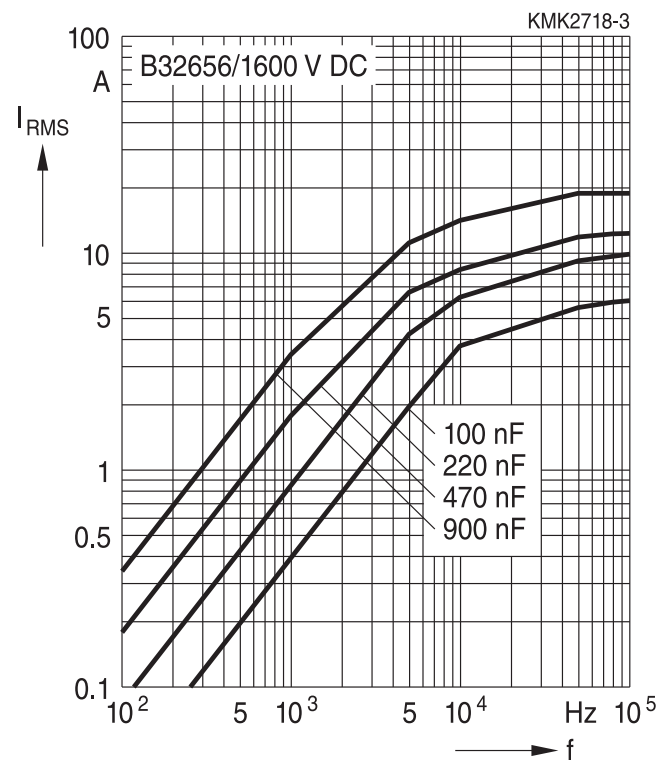

Permissible current I_{RMS} versus frequency f (for sinusoidal waveforms, ambient temperature $T_A \leq 85\text{ }^\circ\text{C}$, self-heating $\Delta T \leq 20\text{ }^\circ\text{C}$ when $\Delta ESR_{typ} \leq \pm 5\%$)
 Lead spacing 37.5 mm

2000 V DC/700 V AC

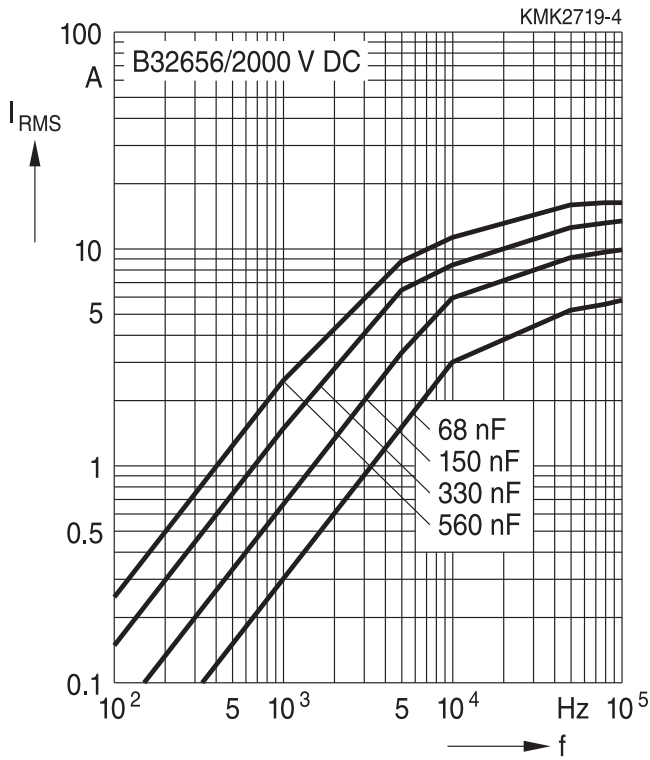

**Permissible current I_{RMS} versus frequency f (for sinusoidal waveforms, ambient temperature $T_A \leq 85\text{ }^\circ\text{C}$, self-heating $\Delta T \leq 20\text{ }^\circ\text{C}$ when $\Delta ESR_{typ} \leq \pm 5\%$)
Lead spacing 52.5 mm**

250 V DC/160 V AC

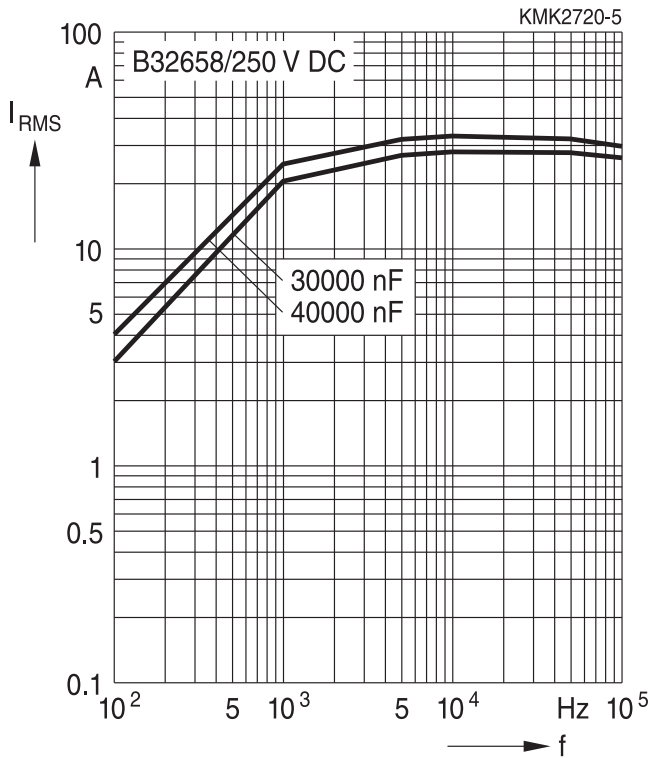

400 V DC/200 V AC

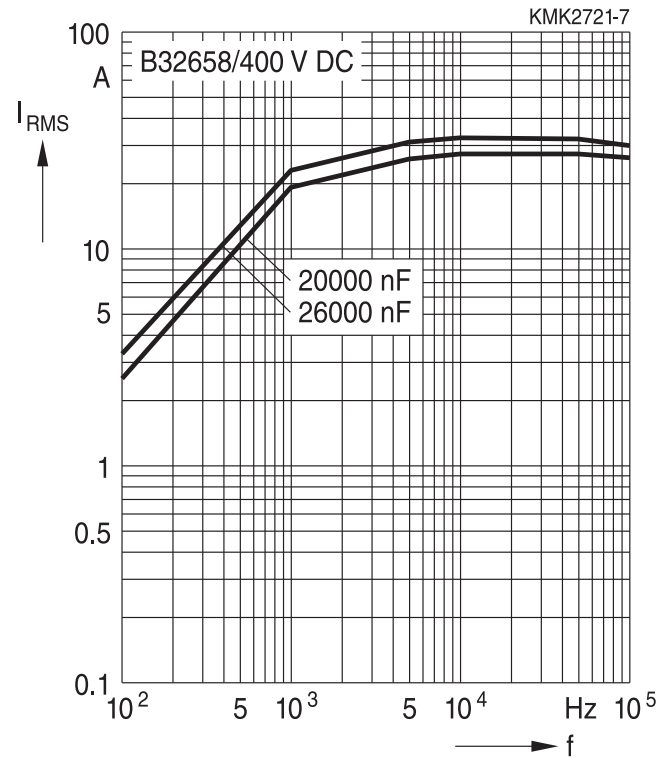

630 V DC/250 V AC

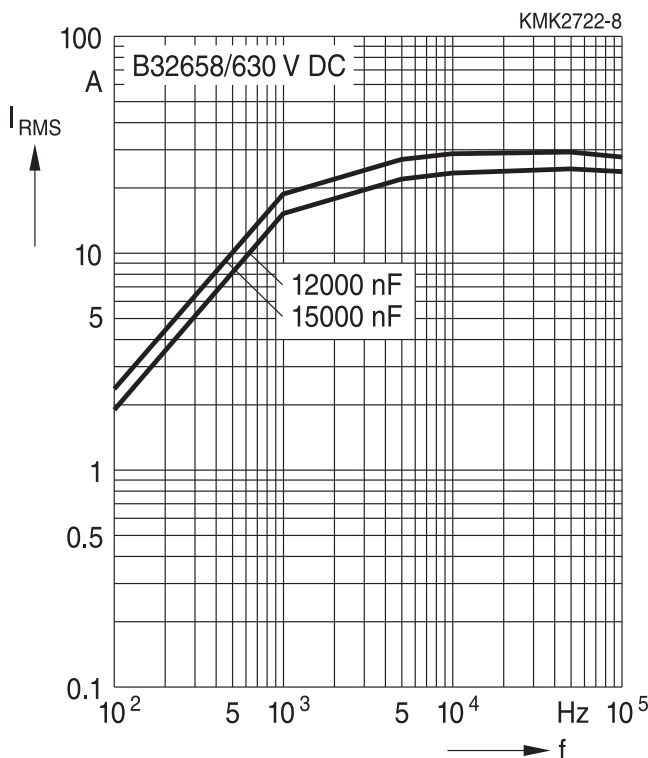

750 V DC/350 V AC

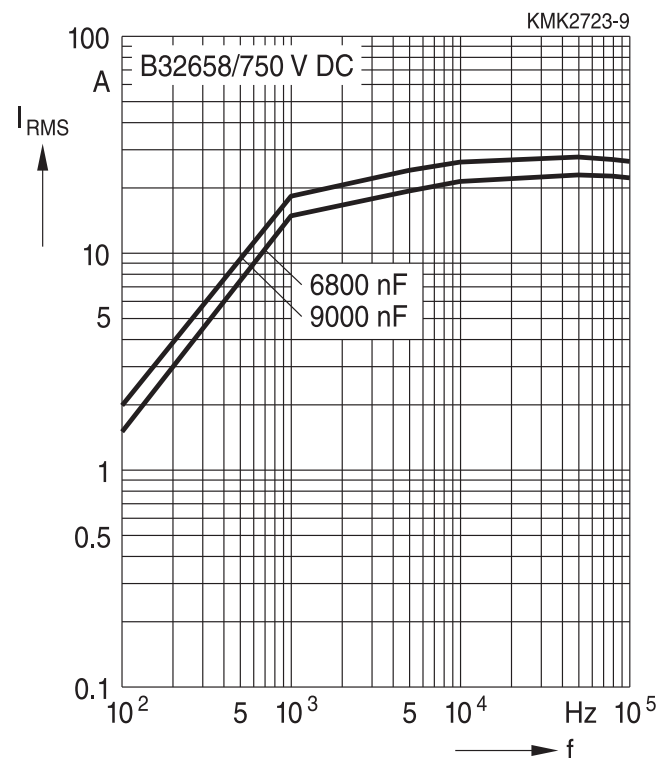

Permissible current I_{RMS} versus frequency f (for sinusoidal waveforms, ambient temperature $T_A \leq 85\text{ }^\circ\text{C}$, self-heating $\Delta T \leq 20\text{ }^\circ\text{C}$ when $\Delta ESR_{typ} \leq \pm 5\%$)
Lead spacing 52.5 mm

850 V DC/450 V AC

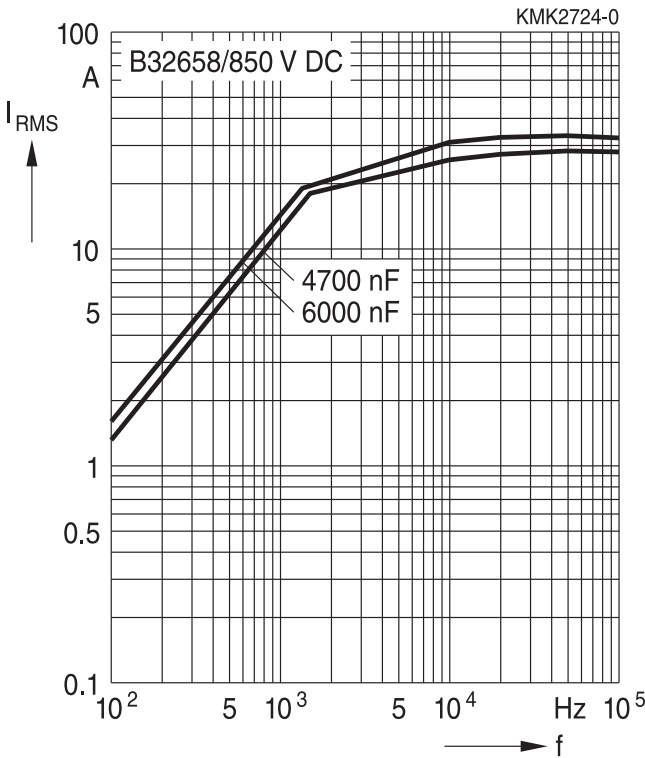

1000 V DC/500 V AC

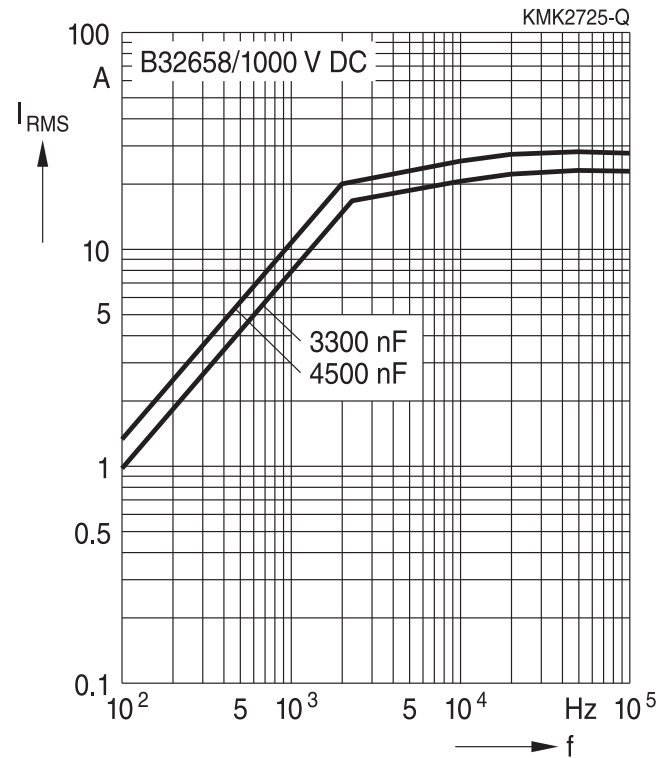

1250 V DC/500 V AC

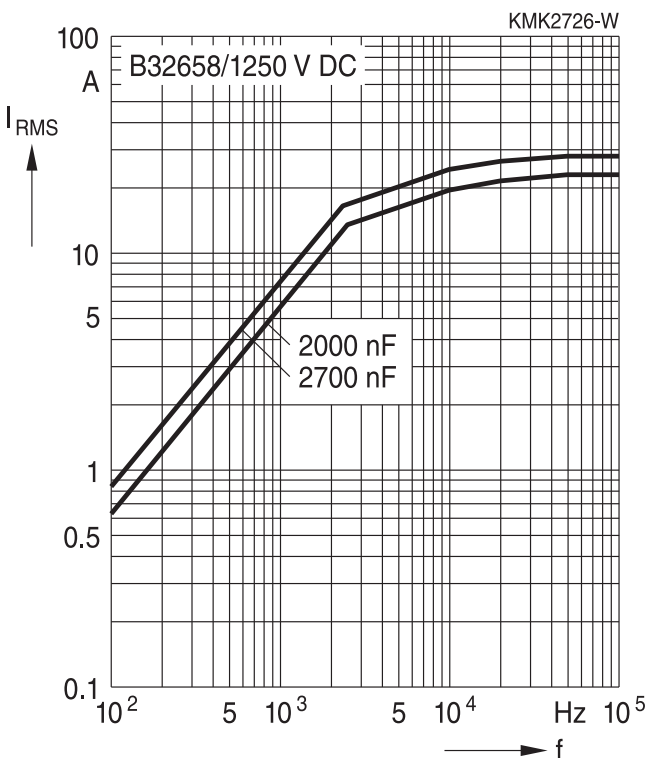

1600 V DC/600 V AC

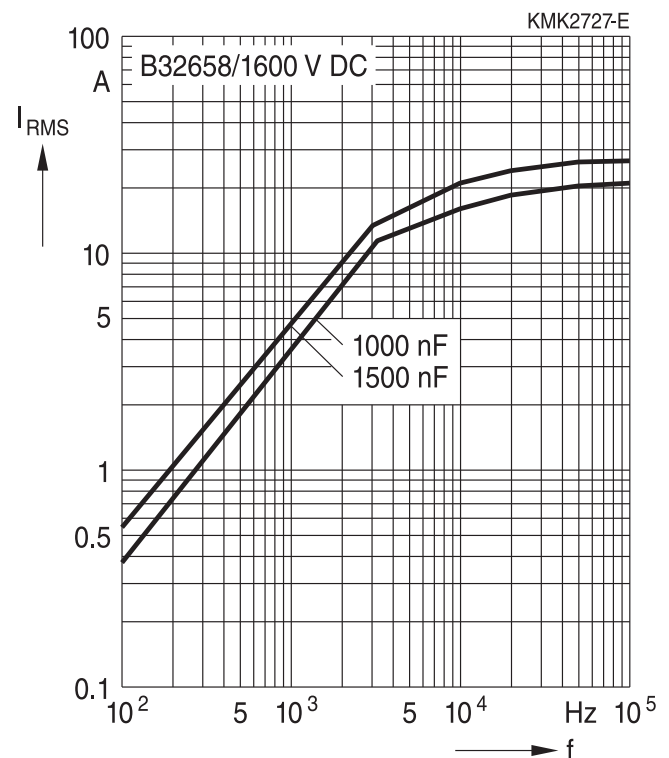

Permissible current I_{RMS} versus frequency f (for sinusoidal waveforms, ambient temperature $T_A \leq 85\text{ }^\circ\text{C}$, self-heating $\Delta T \leq 20\text{ }^\circ\text{C}$ when $\Delta ESR_{typ} \leq \pm 5\%$)
 Lead spacing 52.5 mm

2000 V DC/700 V AC

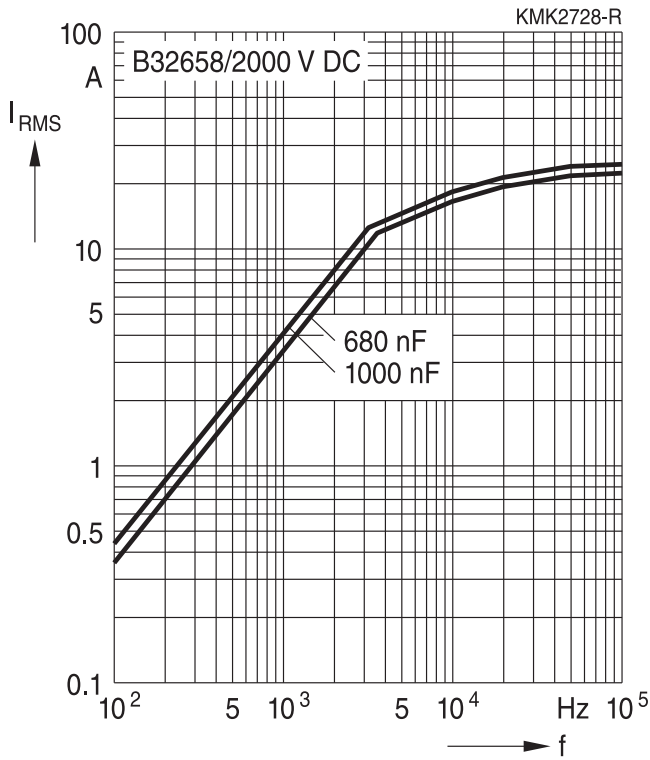

Maximum AC voltage (V_{RMS}), current (I_{RMS}) versus frequency and temperature for $T_A > 85\text{ }^\circ\text{C}$

The graphs described in the previous section for the permissible AC voltage (V_{RMS}) or current (I_{RMS}) versus frequency are given for a maximum ambient temperature $T_A \leq 85\text{ }^\circ\text{C}$. In case of higher ambient temperatures (T_A), the self-heating (ΔT) of the component must be reduced to avoid that temperature of the component ($T_{op} = T_A + \Delta T$) reaches values above maximum operating temperature.

The factor F_T shall be applied in the following way:

Maximum I_{RMS} as function of the ambient temperature:

$$I_{RMS}(T_A) = I_{RMS, T_A \leq 85\text{ }^\circ\text{C}} \cdot F_T(T_A)$$

$$V_{RMS}(T_A) = V_{RMS, T_A \leq 85\text{ }^\circ\text{C}} \cdot F_T(T_A)$$

And F_T is given by the following curve:

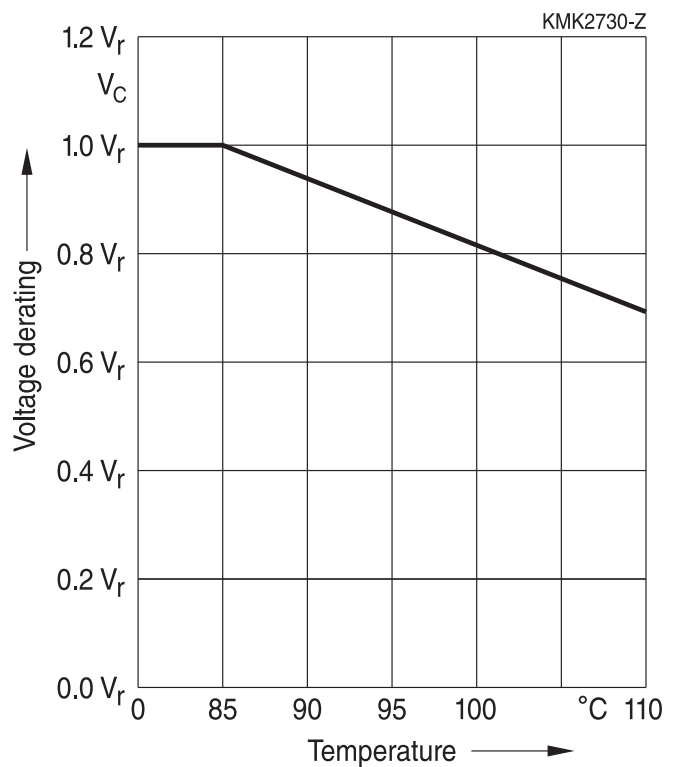
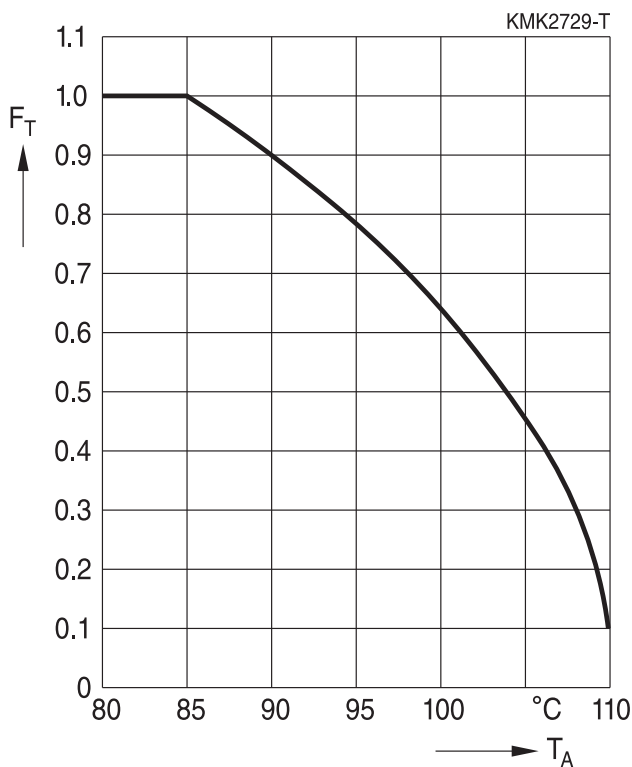
Maximum permissible continuous DC voltage vs. temperature T

Testing and Standards

Test description	Reference	Test conditions	Performance requirements
Electrical parameters	IEC 60384-16	Capacitance: 1 kHz, 1.0 V; Loss factor: 1 kHz, 1.0 V; 100 kHz, 1.0 V; Voltage proof: 1.6 V _R , 1 min; Insulation Resistance: V _R ≥ 500 V, 1 min V _R < 100 V, 1 min	No visible damage Within specified limits
Robustness of terminations	IEC 60068-2-21:2006	Tensile strength (test Ua1)	Capacitance and tan δ within specified limits
		Wire diameter	
		0.5 < d ₁ ≤ 0.8 mm 0.8 < d ₁ ≤ 1.25 mm	10 N 20 N
Resistance to soldering heat	IEC 60068-2-20:2008, test Tb, method 1A	Solder bath temperature at 260 ±5 °C, immersion for 10 ±1 seconds	ΔC/C ₀ ≤ 2% Δ tan δ ≤ 0.002 R _{ins} ≥ 50% of initial limit
Rapid change of temperature	IEC 60384-16:2005	T _A = lower category temperature T _B = upper category temperature Five cycles, duration t = 30 min	No visible damage Capacitance and tan δ within specified limits
Vibration	IEC 60384-16:2005	Test F _C : vibration sinusoidal Displacement: 0.75 mm Acceleration: 98 m/s ² Frequency: 10 Hz ... 500 Hz Test duration: 3 orthogonal axes, 2 hours each axe	No visible damage
Bump	IEC 60384-16:2005	Test Eb: Total 4000 bumps with 390 m/s ² mounted on PCB Duration: 6 ms	No visible damage ΔC/C ₀ ≤ 3% Δ tan δ ≤ 0.002 R _{ins} ≥ 50% of initial limit
Climatic Sequence	IEC 60384-16:2005	Dry heat Tb / 16 h Damp heat cyclic, 1 st cycle +55 °C / 24 h / 95% ... 100% RH Cold Ta / 2 h Damp heat cyclic, 5 cycles +55 °C / 24 h / 95% ... 100% RH	No visible damage ΔC/C ₀ ≤ 2% Δ tan δ ≤ 0.002 R _{ins} ≥ 50% of initial limit
Biased humidity	AEC-Q200	60 °C / 95% RH / V _R /56 days	No visible damage ΔC/C ₀ ≤ 10% Δ tan δ ≤ 0.005 (1 kHz) R _{ins} ≥ 50% of initial limit

Test description	Reference	Test conditions	Performance requirements
Endurance A	IEC 60384-16:2005	85 °C / 1.25 V _R / 2000 hours	No visible damage $ \Delta C/C_0 \leq 5\%$ $ \Delta \tan \delta \leq 0.002$ (1 kHz) $R_{ins} \geq 50\%$ of initial limit
Endurance B	IEC 60384-16:2005	110 °C / 1.25 V _{CR} / 1000 hours	No visible damage $ \Delta C/C_0 \leq 10\%$ $ \Delta \tan \delta \leq 0.004$ (1 kHz) $R_{ins} \geq 50\%$ of initial limit
Endurance C	IEC 60384-16:2005	85 °C / 1.0 V _{RMS} / 2000 hours	No visible damage $ \Delta C/C_0 \leq 10\%$ $ \Delta \tan \delta \leq 0.002$ (1 kHz) $R_{ins} \geq 50\%$ of initial limit
Endurance D	IEC 60384-16:2005	110 °C / 1.0 V _{CRMS} / 1000 hours	No visible damage $ \Delta C/C_0 \leq 10\%$ $ \Delta \tan \delta \leq 0.004$ (1 kHz) $R_{ins} \geq 50\%$ of initial limit

Effect of humidity on capacitance stability

Long contact of a film capacitor with humidity can produce irreversible effects. Direct contact with liquid water or excess exposure to high ambient humidity or dew will eventually remove the film metallization and thus destroy the capacitor. Plastic boxed capacitors must be properly tested in the final application at the worst expected conditions of temperature and humidity in order to check if any parameter drift may provoke a circuit malfunction.

In case of penetration of humidity through the film, the layer of Zinc can be degraded, specially under AC operation (change of polarity), accelerated by the temperature, provoking an increment of the serial resistance of the electrode and eventually a reduction of the capacitance value. For DC operation, the parameter drift is much less.

Plastic boxes and resins cannot protect 100% against humidity. Metal enclosures, resin potting or coatings or similar measures by customers in their applications will offer additional protection against humidity penetration.

Soldering

Solderability of leads

The solderability of terminal leads is tested to IEC 60068-2-20:2008, test Ta, method 1.

Before a solderability test is carried out, terminals are subjected to accelerated ageing (to IEC 60068-2-2:2007, test Ba: 4 h exposure to dry heat at 155 °C). Since the ageing temperature is far higher than the upper category temperature of the capacitors, the terminal wires should be cut off from the capacitor before the ageing procedure to prevent the solderability being impaired by the products of any capacitor decomposition that might occur.

Solder bath temperature	235 ± 5 °C
Soldering time	2.0 ± 0.5 s
Immersion depth	2.0 +0/-0.5 mm from capacitor body or seating plane
Evaluation criteria: Visual inspection	Wetting of wire surface by new solder ≥95%, free-flowing solder

Resistance to soldering heat

Resistance to soldering heat is tested to IEC 60068-2-20:2008, test Tb, method 1.

Conditions:

Series	Solder bath temperature	Soldering time
MKT boxed (except 2.5 × 6.5 × 7.2 mm) coated uncoated (lead spacing >10 mm)	260 ± 5 °C	10 ± 1 s
MFP MKP (lead spacing >7.5 mm)		
MKT boxed (case 2.5 × 6.5 × 7.2 mm)	260 ± 5 °C	5 ± 1 s
MKP (lead spacing ≤7.5 mm)		<4 s recommended soldering profile for MKT uncoated (lead spacing ≤ 10 mm) and insulated (B32559)
MKT uncoated (lead spacing ≤10 mm) insulated (B32559)		

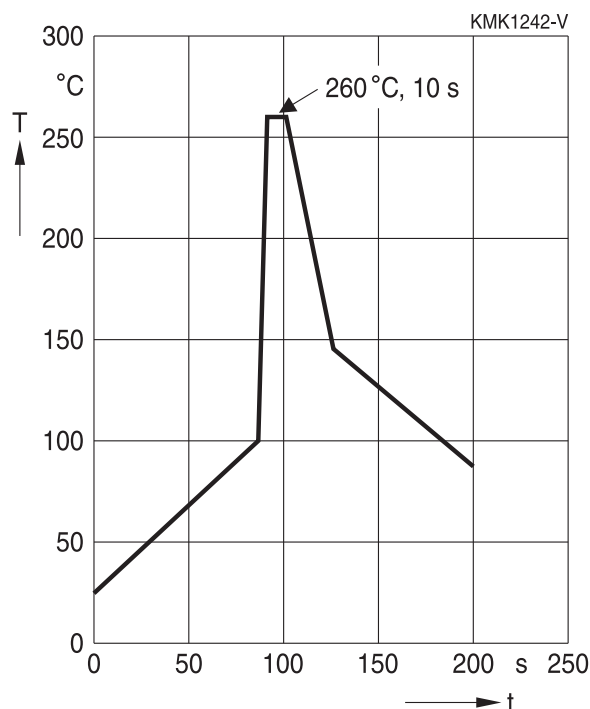

Immersion depth	2.0 +0/-0.5 mm from capacitor body or seating plane
Shield	Heat-absorbing board, (1.5 ± 0.5) mm thick, between capacitor body and liquid solder
Evaluation criteria:	
Visual inspection	No visible damage
$\Delta C/C_0$	2% for MKT/MKP/MFP 5% for EMI suppression capacitors
$\tan \delta$	As specified in sectional specification

General notes on soldering

Permissible heat exposure loads on film capacitors are primarily characterized by the upper category temperature T_{max} . Long exposure to temperatures above this type-related temperature limit can lead to changes in the plastic dielectric and thus change irreversibly a capacitor's electrical characteristics. For short exposures (as in practical soldering processes) the heat load (and thus the possible effects on a capacitor) will also depend on other factors like:

- Pre-heating temperature and time
- Forced cooling immediately after soldering
- Terminal characteristics:
diameter, length, thermal resistance, special configurations (e.g. crimping)
- Height of capacitor above solder bath
- Shadowing by neighboring components
- Additional heating due to heat dissipation by neighboring components
- Use of solder-resist coatings

The overheating associated with some of these factors can usually be reduced by suitable countermeasures. For example, if a pre-heating step cannot be avoided, an additional or reinforced cooling process may possibly have to be included.

TDK Recommendations

As a reference, the recommended wave soldering profile for our film capacitors is as follows:

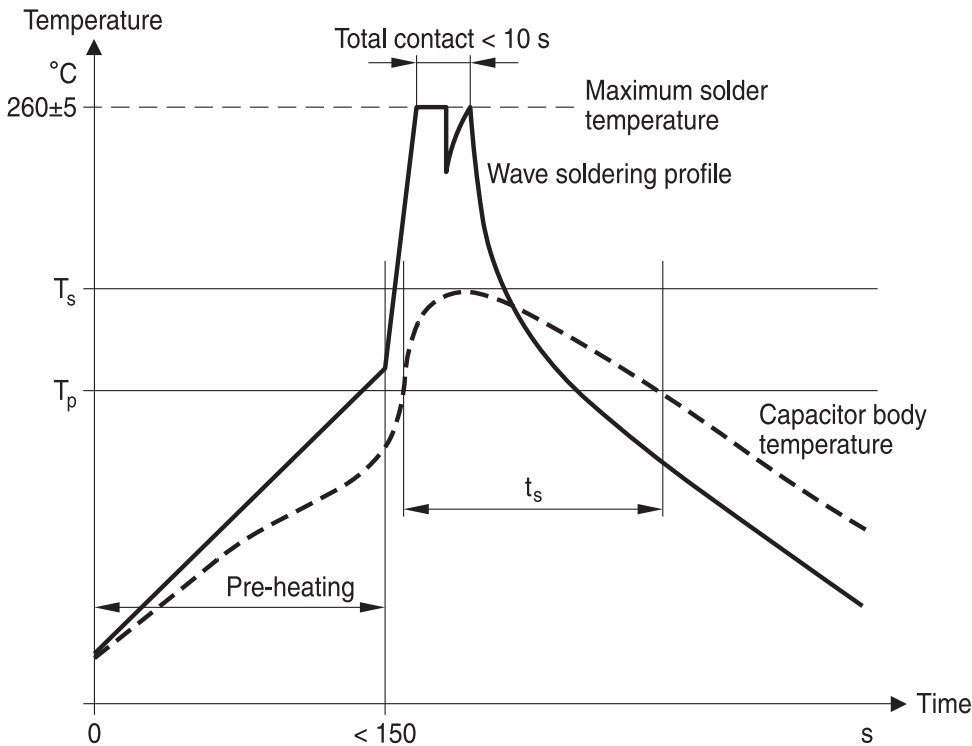

T_s : Capacitor body maximum temperature at wave soldering
 T_p : Capacitor body maximum temperature at pre-heating

KMK1745-A-E

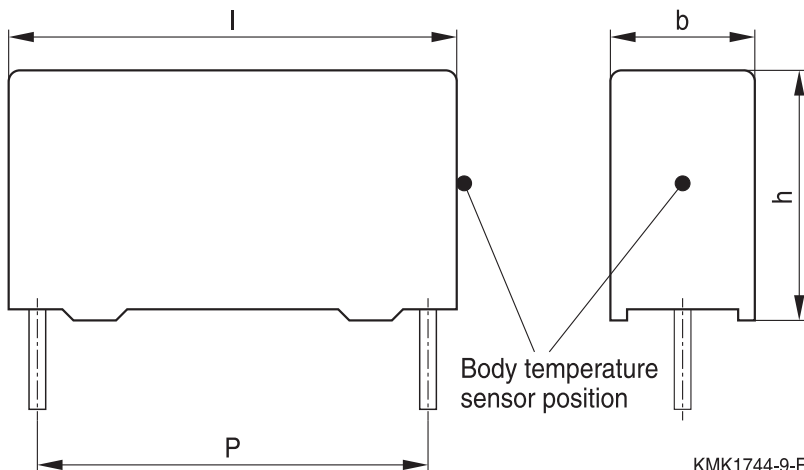

KMK1744-9-E

Body temperature should follow the description below:

- MKP capacitor
 - During pre-heating: $T_p \leq 110 \text{ }^\circ\text{C}$
 - During soldering: $T_s \leq 120 \text{ }^\circ\text{C}$, $t_s \leq 45 \text{ s}$
- MKT capacitor
 - During pre-heating: $T_p \leq 125 \text{ }^\circ\text{C}$
 - During soldering: $T_s \leq 160 \text{ }^\circ\text{C}$, $t_s \leq 45 \text{ s}$

When SMD components are used together with leaded ones, the film capacitors should not pass into the SMD adhesive curing oven. The leaded components should be assembled after the SMD curing step.

Leaded film capacitors are not suitable for reflow soldering.

In order to ensure proper conditions for manual or selective soldering, the body temperature of the capacitor (T_s) must be ≤ 120 °C.

One recommended condition for manual soldering is that the tip of the soldering iron should be < 360 °C and the soldering contact time should be no longer than 3 seconds.

For uncoated MKT capacitors with lead spacings ≤ 10 mm (B32560/B32561) the following measures are recommended:

- pre-heating to not more than 110 °C in the preheater phase
- rapid cooling after soldering

Cleaning

To determine whether the following solvents, often used to remove flux residues and other substances, are suitable for the capacitors described, refer to the table below:

Type	Ethanol, isopropanol, n-propanol	n-propanol-water mixtures, water with surface tension-reducing tensides (neutral)
MKT (uncoated)	Suitable	Unsuitable
MKT, MKP, MFP (coated/boxed)		Suitable

Even when suitable solvents are used, a reversible change of the electrical characteristics may occur in uncoated capacitors immediately after they are washed. Thus it is always recommended to dry the components (e.g. 4 h at 70 °C) before they are subjected to subsequent electrical testing.

Caution:

Consult us first if you wish to use new solvents!

Embedding of capacitors in finished assemblies

In many applications, finished circuit assemblies are embedded in plastic resins. In this case, both chemical and thermal influences of the embedding ("potting") and curing processes must be taken into account.

Our experience has shown that the following potting materials can be recommended: non-flexible epoxy resins with acid-anhydride hardeners; chemically inert, non-conducting fillers; maximum curing temperature of 100°C.

Caution:

Consult us first if you wish to embed uncoated types!

Marking

Capacitor markings

Depending on the capacitor size, the markings are positioned either on the side and/or the top of the component. The coded forms specified in IEC 60062:2004 are used to indicate the rated capacitance, capacitance tolerance and date of manufacture.

The lot number (production batch number) ensures unique identification of a particular capacitor and allows, together with the date of manufacture, exact assignment to the process data of the entire production run (traceability).

If the capacitor is not wide enough for the entire marking, the information in the marking will be split between the top and side. In this case, the following partial information will be found on the top:

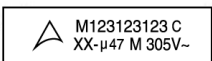
Manufacturer's logo  Lot number, Revision status
Date code, Capacitance,
Cap. tolerance, Rated voltage

Codes for rated capacitance

Rated capacitance	To IEC 60062	Short code
100 pF	100p	n1
150 pF	150p	n15
1.0 nF	1n0	1n
1.5 nF	1n5	
10 nF	10n	
100 nF	100n	μ1
150 nF	150n	μ15
1.0 μF	1μ0	1μ
1.5 μF	1μ5	
10 μF	10μ	
15 μF	15μ	

Codes for capacitance tolerance

Capacitance tolerance	Code letter	Remark
	A	Capacitance tolerances for which no code letter is defined can be indicated by an A. The meaning of code A must then be mutually specified in other documentation.
±2.5%	H	
±5%	J	
±10%	K	
±20%	M	

Codes for date of manufacture (to IEC 60062:2004)

Code for year				Code for month			
Year	Code letter	Year	Code letter	Month	Code numeral	Month	Code numeral/letter
2023	R	2029	X	January	1	July	7
2024	S	2030	A	February	2	August	8
2025	T	2031	B	March	3	September	9
2026	U	2032	C	April	4	October	O
2027	V	2033	D	May	5	November	N
2028	W	2034	E	June	6	December	D

E.g.: R5 2023 May

Marking types

The capacitors may have either an ink-jet marking or a laser marking. The main advantage of laser marking is that it cannot be removed by solvents, which ensures the reliable identification of the capacitor. Moreover, because the laser marking process reduces the amount of chemicals used, it is an environmentally friendly marking solution.

Ordering code system

A component and the packing in which it is to be delivered are defined by the ordering code, which has 15 digits (plus 3 additional digits for internal use). For all capacitors the ordering codes are explicitly stated (together with the corresponding tolerance and/or packing variants) in the data sheets.

Should there be any doubt about the coding system, however, then it is better to order the capacitor using a plain text description (i.e. without a code).

Basic structure of the ordering code:

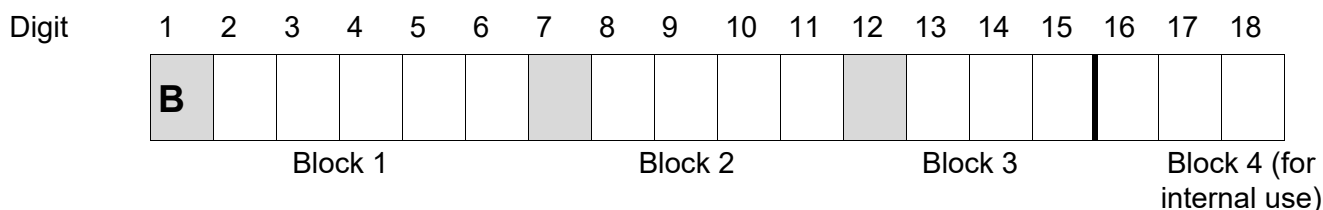

Digit	Meaning																										
1	B = Passive components																										
2,3	32 = Metallized film capacitors, EMI suppression capacitors 81 = EMI suppression capacitors																										
4 ... 6	Type (block 1 is termed the "type number")																										
7	Revision status																										
8	Rated DC voltage, coded (not for EMI suppression capacitors)																										
9 ... 11	Rated capacitance (coding method for value in pF) Examples:																										
	<table style="margin-left: auto; margin-right: auto;"> <tr> <td style="border: 1px solid black; padding: 2px;">1</td> <td style="border: 1px solid black; padding: 2px;">5</td> <td style="border: 1px solid black; padding: 2px;">4</td> <td style="padding: 0 5px;">K</td> <td style="padding: 0 5px;">=</td> <td style="padding: 0 5px;">15</td> <td style="padding: 0 5px;">•</td> <td style="padding: 0 5px;">10</td> <td style="padding: 0 5px;">4</td> <td style="padding: 0 5px;">pF</td> <td style="padding: 0 5px;">=</td> <td style="padding: 0 5px;">150</td> <td style="padding: 0 5px;">nF</td> </tr> <tr> <td colspan="13" style="text-align: center;"> <div style="display: flex; justify-content: center; align-items: center; gap: 10px;"> B 3 2 6 4 2 H 6 <div style="display: flex; flex-direction: column; align-items: center;"> <div style="display: flex; gap: 5px;"> 9 10 11 </div> <div style="display: flex; gap: 5px;"> 1 5 4 </div> </div> </div></td> </tr> </table>	1	5	4	K	=	15	•	10	4	pF	=	150	nF	<div style="display: flex; justify-content: center; align-items: center; gap: 10px;"> B 3 2 6 4 2 H 6 <div style="display: flex; flex-direction: column; align-items: center;"> <div style="display: flex; gap: 5px;"> 9 10 11 </div> <div style="display: flex; gap: 5px;"> 1 5 4 </div> </div> </div>												
1	5	4	K	=	15	•	10	4	pF	=	150	nF															
<div style="display: flex; justify-content: center; align-items: center; gap: 10px;"> B 3 2 6 4 2 H 6 <div style="display: flex; flex-direction: column; align-items: center;"> <div style="display: flex; gap: 5px;"> 9 10 11 </div> <div style="display: flex; gap: 5px;"> 1 5 4 </div> </div> </div>																											
12	Code letter for capacitance tolerance																										
13 ... 15	Codes for lead and taping parameters (refer to respective data sheet)																										
16 ... 18	Internal use																										

Display of ordering codes for TDK Electronics products

The ordering code for one and the same product can be represented differently in data sheets, data books, other publications, on the company website, or in order-related documents such as shipping notes, order confirmations and product labels. **The varying representations of the ordering codes are due to different processes employed and do not affect the specifications of the respective products.** Detailed information can be found on the Internet under www.tdk-electronics.tdk.com/orderingcodes.

Cautions and warnings

- Do not exceed the upper category temperature (UCT).
- Do not apply any mechanical stress to the capacitor terminals.
- Avoid any compressive, tensile or flexural stress.
- Do not move the capacitor after it has been soldered to the PC board.
- Do not pick up the PC board by the soldered capacitor.
- Do not place the capacitor on a PC board whose PTH hole spacing differs from the specified lead spacing.
- Do not exceed the specified time or temperature limits during soldering.
- Avoid external energy inputs, such as fire or electricity.
- Avoid overload of the capacitors.
- Consult us if application is with severe temperature and humidity condition.
- There are no serviceable or repairable parts inside the capacitor. Opening the capacitor or any attempts to open or repair the capacitor will void the warranty and liability of TDK Electronics.
- Please note that the standards referred to in this publication may have been revised in the meantime.

The table below summarizes the safety instructions that must always be observed. A detailed description can be found in the relevant sections of the chapters "General technical information" and "Mounting guidelines".

Topic	Safety information	Reference chapter "General technical information"
Storage conditions	Make sure that capacitors are stored within the specified range of time, temperature and humidity conditions.	4.5 "Storage conditions"
Flammability	Avoid external energy, such as fire or electricity (passive flammability), avoid overload of the capacitors (active flammability) and consider the flammability of materials.	5.3 "Flammability"
Resistance to vibration	Do not exceed the tested ability to withstand vibration. The capacitors are tested to IEC 60068-2-6:2007. TDK Electronics offers film capacitors specially designed for operation under more severe vibration regimes such as those found in automotive applications. Consult our catalog "Film Capacitors for Automotive Electronics".	5.2 "Resistance to vibration"
Soldering	Do not exceed the specified time or temperature limits during soldering.	1 "Soldering"
Cleaning	Use only suitable solvents for cleaning capacitors.	2 "Cleaning"
Embedding of capacitors in finished assemblies	When embedding finished circuit assemblies in plastic resins, chemical and thermal influences must be taken into account. Caution: Consult us first, if you also wish to embed other uncoated component types!	3 "Embedding of capacitors in finished assemblies"

Display of ordering codes for TDK Electronics products

The ordering code for one and the same product can be represented differently in data sheets, data books, other publications, on the company website, or in order-related documents such as shipping notes, order confirmations and product labels. The varying representations of the ordering codes are due to different processes employed and do not affect the specifications of the respective products.

Detailed information can be found on the Internet under www.tdk-electronics.tdk.com/orderingcodes.

Correlation of data sheet values and modelling tool outputs

Data sheet values and results of design tools may deviate as they have not been derived in the same context.

While data sheets show individual parameter statements without considering a possible dependency to other parameters. Tools model a complete given scenario as input and processed inside the tool.

Furthermore as we constantly strive to improve our models, the results of tools can change over time and be a non-binding indication only.

Symbols and terms

Symbol	English	German
α	Heat transfer coefficient	Wärmeübergangszahl
α_C	Temperature coefficient of capacitance	Temperaturkoeffizient der Kapazität
A	Capacitor surface area	Kondensatoroberfläche
β_C	Humidity coefficient of capacitance	Feuchtekoeffizient der Kapazität
C	Capacitance	Kapazität
C_R	Rated capacitance	Nennkapazität
ΔC	Absolute capacitance change	Absolute Kapazitätsänderung
$\Delta C/C$	Relative capacitance change (relative deviation of actual value)	Relative Kapazitätsänderung (relative Abweichung vom Ist-Wert)
$\Delta C/C_R$	Capacitance tolerance (relative deviation from rated capacitance)	Kapazitätstoleranz (relative Abweichung vom Nennwert)
dt	Time differential	Differentielle Zeit
Δt	Time interval	Zeitintervall
ΔT	Absolute temperature change (self-heating)	Absolute Temperaturänderung (Selbsterwärmung)
$\Delta \tan \delta$	Absolute change of dissipation factor	Absolute Änderung des Verlustfaktors
ΔV	Absolute voltage change	Absolute Spannungsänderung
dV/dt	Time differential of voltage function (rate of voltage rise)	Differentielle Spannungsänderung (Spannungsflankensteilheit)
$\Delta V/\Delta t$	Voltage change per time interval	Spannungsänderung pro Zeitintervall
E	Activation energy for diffusion	Aktivierungsenergie zur Diffusion
ESL	Self-inductance	Eigeninduktivität
ESR	Equivalent series resistance	Ersatz-Serienwiderstand
f	Frequency	Frequenz
f_1	Frequency limit for reducing permissible AC voltage due to thermal limits	Grenzfrequenz für thermisch bedingte Reduzierung der zulässigen Wechselspannung
f_2	Frequency limit for reducing permissible AC voltage due to current limit	Grenzfrequenz für strombedingte Reduzierung der zulässigen Wechselspannung
f_r	Resonant frequency	Resonanzfrequenz
F_D	Thermal acceleration factor for diffusion	Therm. Beschleunigungsfaktor zur Diffusion
F_T	Derating factor	Deratingfaktor
i	Current (peak)	Stromspitze
I_C	Category current (max. continuous current)	Kategoriestrom (max. Dauerstrom)
I_{RMS}	(Sinusoidal) alternating current, root-mean- square value	(Sinusförmiger) Wechselstrom
i_z	Capacitance drift	Inkonstanz der Kapazität
k_0	Pulse characteristic	Impulskennwert
L_S	Series inductance	Serieninduktivität
λ	Failure rate	Ausfallrate

Symbol	English	German
λ_0	Constant failure rate during useful service life	Konstante Ausfallrate in der Nutzungsphase
λ_{test}	Failure rate, determined by tests	Experimentell ermittelte Ausfallrate
P_{diss}	Dissipated power	Abgegebene Verlustleistung
P_{gen}	Generated power	Erzeugte Verlustleistung
Q	Heat energy	Wärmeenergie
ρ	Density of water vapor in air	Dichte von Wasserdampf in Luft
R	Universal molar constant for gases	Allg. Molarkonstante für Gas
R	Ohmic resistance of discharge circuit	Ohmscher Widerstand des Entladekreises
R_i	Internal resistance	Innenwiderstand
R_{ins}	Insulation resistance	Isolationswiderstand
R_p	Parallel resistance	Parallelwiderstand
R_s	Series resistance	Serienwiderstand
S	severity (humidity test)	Schärfegrad (Feuchtetest)
t	Time	Zeit
T	Temperature	Temperatur
τ	Time constant	Zeitkonstante
$\tan \delta$	Dissipation factor	Verlustfaktor
$\tan \delta_D$	Dielectric component of dissipation factor	Dielektrischer Anteil des Verlustfaktors
$\tan \delta_p$	Parallel component of dissipation factor	Parallelanteil des Verlustfaktors
$\tan \delta_s$	Series component of dissipation factor	Serienanteil des Verlustfaktors
T_A	Temperature of the air surrounding the component	Temperatur der Luft, die das Bauteil umgibt
T_{max}	Upper category temperature	Obere Kategorietemperatur
T_{min}	Lower category temperature	Untere Kategorietemperatur
t_{OL}	Operating life at operating temperature and voltage	Betriebszeit bei Betriebstemperatur und -spannung
T_{op}	Operating temperature, $T_A + \Delta T$	Betriebstemperatur, $T_A + \Delta T$
T_R	Rated temperature	Nenntemperatur
T_{ref}	Reference temperature	Referenztemperatur
t_{SL}	Reference service life	Referenz-Lebensdauer
V_{AC}	AC voltage	Wechselspannung
V_C	Category voltage	Kategoriespannung
$V_{\text{C,RMS}}$	Category AC voltage	(Sinusförmige) Kategorie-Wechselspannung
V_{CD}	Corona-discharge onset voltage	Teilentlade-Einsatzspannung
V_{ch}	Charging voltage	Ladespannung
V_{DC}	DC voltage	Gleichspannung
V_{FB}	Fly-back capacitor voltage	Spannung (Flyback)
V_i	Input voltage	Eingangsspannung

Symbol	English	German
V_o	Output voltage	Ausgangssspannung
V_{op}	Operating voltage	Betriebsspannung
V_p	Peak pulse voltage	Impuls-Spitzenspannung
V_{pp}	Peak-to-peak voltage Impedance	Spannungshub
V_R	Rated voltage	Nennspannung
\checkmark_R	Amplitude of rated AC voltage	Amplitude der Nenn-Wechselspannung
V_{RMS}	(Sinusoidal) alternating voltage, root-mean-square value	(Sinusförmige) Wechselspannung
V_{SC}	S-correction voltage	Spannung bei Anwendung "S-correction"
V_{sn}	Snubber capacitor voltage	Spannung bei Anwendung "Beschaltung"
Z	Impedance	Scheinwiderstand
e	Lead spacing	Rastermaß

The following applies to all products named in this publication:

- 1 Some parts of this publication contain **statements about the suitability of our products for certain areas of application**. These statements are based on our knowledge of typical requirements that are often placed on our products in the areas of application concerned. We nevertheless expressly point out **that such statements cannot be regarded as binding statements about the suitability of our products for a particular customer application**. As a rule we are either unfamiliar with individual customer applications or less familiar with them than the customers themselves. For these reasons, it is always ultimately incumbent on the customer to check and decide whether a product with the properties described in the product specification is suitable for use in a particular customer application.
- 2 We also point out that **in individual cases, a malfunction of electronic components or failure before the end of their usual service life cannot be completely ruled out in the current state of the art, even if they are operated as specified**. In customer applications requiring a very high level of operational safety and especially in customer applications in which the malfunction or failure of an electronic component could endanger human life or health (e.g. in accident prevention or life-saving systems), it must therefore be ensured by means of suitable design of the customer application or other action taken by the customer (e.g. installation of protective circuitry or redundancy) that no injury or damage is sustained by third parties in the event of malfunction or failure of an electronic component.
- 3 **The warnings, cautions and product-specific notes must be observed.**
- 4 In order to satisfy certain technical requirements, **some of the products described in this publication may contain substances subject to restrictions in certain jurisdictions (e.g. because they are classed as hazardous)**. Useful information on this will be found in our Material Data Sheets on the Internet (www.tdk-electronics.tdk.com/material). Should you have any more detailed questions, please contact our sales offices.
- 5 We constantly strive to improve our products. Consequently, **the products described in this publication may change from time to time**. The same is true of the corresponding product specifications. Please check therefore to what extent product descriptions and specifications contained in this publication are still applicable before or when you place an order.
We also **reserve the right to discontinue production and delivery of products**. Consequently, we cannot guarantee that all products named in this publication will always be available. The aforementioned does not apply in the case of individual agreements deviating from the foregoing for customer-specific products.
- 6 Unless otherwise agreed in individual contracts, **all orders are subject to our General Terms and Conditions of Supply**.
- 7 **Our manufacturing sites serving the automotive business apply the IATF 16949 standard**. The IATF certifications confirm our compliance with requirements regarding the quality management system in the automotive industry. Referring to customer requirements and customer specific requirements ("CSR") TDK always has and will continue to have the policy of respecting individual agreements. Even if IATF 16949 may appear to support the acceptance of unilateral requirements, we hereby like to emphasize that **only requirements mutually agreed upon can and will be implemented in our Quality Management System**. For clarification purposes we like to point out that obligations from IATF 16949 shall only become legally binding if individually agreed upon.

Important Notes

- 8 The trade names EPCOS, CarXield, CeraCharge, CeraDiode, CeraLink, CeraPad, CeraPlas, CSMP, CTVS, DeltaCap, DigiSiMic, FilterCap, FormFit, InsuGate, LeaXield, MediPlas, MiniBlue, MiniCell, MKD, MKK, ModCap, MotorCap, PCC, PhaseCap, PhaseCube, PhaseMod, PhiCap, PiezoBrush, PlasmaBrush, PowerHap, PQSine, PQvar, SIFERRIT, SIFI, SIKOREL, SilverCap, SIMDAD, SiMic, SIMID, SineFormer, SIOV, SurfIND, ThermoFuse, WindCap, XieldCap are **trademarks registered or pending** in Europe and in other countries. Further information will be found on the Internet at www.tdk-electronics.tdk.com/trademarks.

Release 2024-02