

Power relays (Over 2 A)
LF-G RELAYS

Product Catalog

**IN Your
Future**

LF-G RELAYS

Load for solar inverter, Compact size, 1 Form A 22 A/33 A, Power relays

Protective construction : Flux-resistant type



(Unit : mm)

FEATURES

- High capacity control possible at 22 A/33 A (High capacity type) 250 V AC rating in compact size
- Contact GAP: 1.5 mm, 1.8 mm
Compliant with photovoltaic standard (IEC62109 and VDE0126)
- Coil holding voltage contributes to saving energy of equipment
- Comforms to various safety standards: UL/C-UL and VDE

TYPICAL APPLICATIONS

- Photovoltaic power generation systems (Solar inverter)
- Uninterruptible Power Supplies (UPS)
- Home appliances
- Office equipment

DETAILS FEATURES

■ Contact GAP: 1.5 mm, 1.8 mm*1

Compliant with European photovoltaic standard (IEC62109*2 and VDE0126*3).

EN61810-1 certified: 2.5 kV surge withstand voltage (between contacts)

*1. Safety standard of PV power inverter

*2. German safety standard of PV power inverter

*3. Due to addition of altitude stipulation (Min. 2,000 m) to IEC62109.

■ High capacity control possible at 22 A/33 A (High capacity type) 250 V AC rating in compact size (L: 15.7 × W: 30.1 × H: 23.3 mm)

■ Coil holding voltage*1 contributes to saving energy of equipment

The coil holding voltage can be reduced up to 35% V of the rated coil voltage (Ambient temperature: 20°C*2). Operating power at the lowest coil holding voltage: 170 mW equivalent

*1. Coil holding voltage is the coil voltage after 100 ms from the applied rated coil voltage.

*2. When the ambient temperature during use is 85°C, make the coil holding voltage between 45 to 80% V of the rated coil voltage.

■ High insulation

Creepage distance between contact and coil terminal:
Min. 9.5 mm

Clearance distance between contact and coil terminal:
Min. 6.5 mm

Surge withstand voltage: 6 kV

ORDERING INFORMATION (PART NO.)

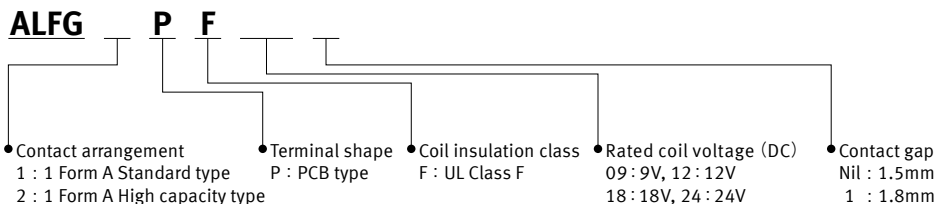

Note : Certified by UL/C-UL and VDE

Power relays (Over 2 A) LF-G RELAYS

TYPES

Contact arrangement	Rated coil voltage	Part No.				Standard packing	
		Contact GAP 1.5 mm		Contact GAP 1.8 mm		Inner carton	Outer carton
		Standard type	High capacity type	Standard type	High capacity type		
1 Form A	9 V DC	ALFG1PF09	ALFG2PF09	ALFG1PF091	ALFG2PF091	50 pcs.	200 pcs.
	12 V DC	ALFG1PF12	ALFG2PF12	ALFG1PF121	ALFG2PF121		
	18 V DC	ALFG1PF18	ALFG2PF18	ALFG1PF181	ALFG2PF181		
	24 V DC	ALFG1PF24	ALFG2PF24	ALFG1PF241	ALFG2PF241		

RATING

Coil data

- Operating characteristics such as 'Operate voltage' and 'Release voltage' are influenced by mounting conditions, ambient temperature, etc.

Therefore, please use the relay within $\pm 5\%$ of rated coil voltage.

- 'Initial' means the condition of products at the time of delivery.

Rated coil voltage	Operate voltage* (at 20°C)	Release voltage* (at 20°C)	Rated operating current ($\pm 10\%$, at 20°C)	Coil resistance ($\pm 10\%$, at 20°C)	Rated operating power	Max. allowable voltage (at 20°C)
9 V DC	Max. 70% V of rated coil voltage (Initial)	Min. 10% V of rated coil voltage (Initial)	155 mA	58 Ω	1,400 mW	120% V of rated coil voltage
12 V DC			117 mA	103 Ω		
18 V DC			78 mA	230 Ω		
24 V DC			59 mA	410 Ω		

*square, pulse drive

Specifications

Item		Specifications		
		Standard type	High capacity type	
		Contact GAP 1.5 mm, 1.8 mm	Contact GAP 1.5 mm	Contact GAP 1.8 mm
Contact data	Contact arrangement	1 Form A		
	Contact resistance (initial)	Max. 100 mΩ (by voltage drop 6 V DC 1 A)		
	Contact material	AgSnO ₂ type		
	Contact rating (resistive)	22 A 250 V AC	31 A 250 V AC	33 A 250 V AC
	Max. switching power (resistive)	5,500 VA	7,750 VA	8,250 VA
	Max. switching voltage	250V AC		
	Max. switching current	22 A (AC)	31 A (AC)	33 A (AC)
	Min. switching load (reference value)*1	100 mA 5 V DC		
Insulation resistance (initial)		Min. 1,000 MΩ (at 500 V DC, Measured portion is the same as the case of dielectric strength.)		
Dielectric strength (initial)	Between open contacts	2,500 Vrms for 1 min (detection current: 10 mA)		
	Between contact and coil	4,000 Vrms for 1 min (detection current: 10 mA)		
Surge withstand voltage (initial)*2	Between contact and coil	6,000 V		
Coil holding voltage*3		35 to 120% V (at 20°C, contact carrying current 22 A) 45 to 80% V (at 85°C, contact carrying current 22 A)	35 to 120% V (at 20°C, contact carrying current 31 A) 45 to 80% V (at 85°C, contact carrying current 31 A)	35 to 120% V (at 20°C, contact carrying current 33 A) 45 to 80% V (at 85°C, contact carrying current 33 A)
Time characteristics (initial)	Operate time	Max. 20 ms at rated coil voltage (at 20°C, without bounce)		
	Release time	Max. 10 ms at rated coil voltage (at 20°C, without bounce, without diode)		
Shock resistance	Functional	100 m/s ² (half-sine shock pulse: 11 ms, detection time: 10 μs)		
	Destructive	1,000 m/s ² (half-sine shock pulse: 6 ms)		
Vibration resistance	Functional	10 to 55 Hz (at double amplitude of 1.5 mm, detection time: 10 μs)		
	Destructive	10 to 55 Hz (at double amplitude of 1.5 mm)		
Expected life	Mechanical life	Contact GAP 1.5 mm: Min. 10 ⁶ (switching frequency: 180 times/min) Contact GAP 1.8 mm: Min. 500 x 10 ³ (switching frequency: 180 times/min)		
Conditions	Conditions for usage, transport and storage*4	Ambient temperature: -40 to +60°C (When rated coil voltage applied) -40 to +85°C (Coil holding voltage is when 45 to 80% V of rated coil voltage is applied.) Humidity: 5 to 85% RH (Avoid icing and condensation)		
Unit weight		Approx. 23 g		

*1. This value can change due to the switching frequency, environmental conditions, and desired reliability level, therefore it is recommended to check this with the actual load.

*2. Wave is standard shock voltage of $\pm 1.2 \times 50 \mu\text{s}$ according to JEC-212-1981

*3. Coil holding voltage is the coil voltage after 100 ms from the applied rated coil voltage.

*4. For ambient temperature, please read "GUIDELINES FOR RELAY USAGE".

Expected electrical life

Type	Contact GAP	Load	Switching capacity	Number of operations
Standard type	1.5 mm/1.8 mm	Resistive load	22 A 250 V AC	Min. 30 x 10 ³ (switching frequency 20 times/min)
		Destructive	22 A 250 V AC (cosφ = 0.8)	Min. 30 x 10 ³ (switching frequency ON : OFF = 0.1 s : 10 s)
		Over load	35 A 250 V AC (cosφ = 0.8)	Min. 50 (switching frequency ON : OFF = 0.1 s : 10 s)
High capacity type	1.5 mm	Destructive	31 A 250 V AC (cosφ = 0.8)	Min. 30 x 10 ³ (switching frequency ON : OFF = 0.1 s : 10 s)
		Over load	47 A 250 V AC (cosφ = 0.8)	Min. 50 (switching frequency ON : OFF = 0.1 s : 10 s)
	1.8 mm	Destructive	33 A 250 V AC (cosφ = 0.8)	Min. 30 x 10 ³ (switching frequency ON : OFF = 0.1 s : 10 s)
		Over load	50 A 250 V AC (cosφ = 0.8)	Min. 50 (switching frequency ON : OFF = 0.1 s : 10 s)

REFERENCE DATA

Standard type (Contact GAP 1.5 mm, 1.8 mm)

1-1. Electrical life test (22 A 250 V AC Resistive load)

Tested sample : ALFG1PF09, ALFG1PF091, 6 pcs.
 Operation frequency : ON : OFF = 1.5s : 1.5s
 Ambient temperature : 85°C
 Circuit :

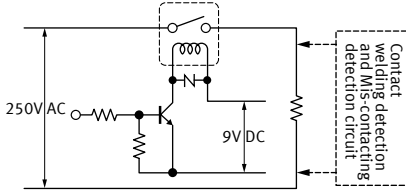

Change of operate and release voltage

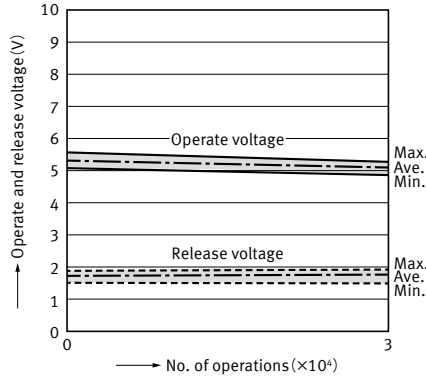

Change of contact resistance

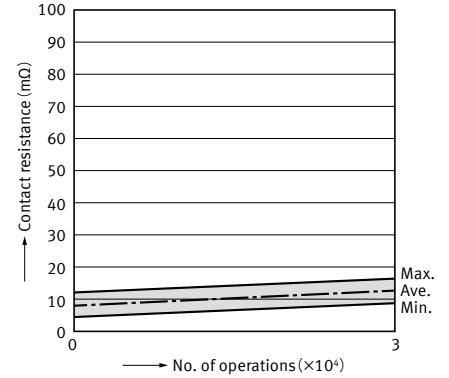

1-2. Electrical life test (22 A 250 V AC cosφ = 0.8 Inductive load)

Tested sample : ALFG1PF09, ALFG1PF091, 6 pcs.
 Operation frequency : ON : OFF = 0.1s : 10s
 Ambient temperature : 85°C
 Circuit :

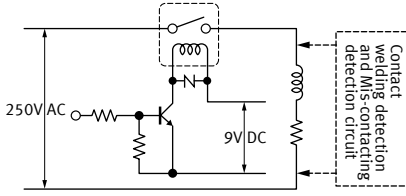

Change of operate and release voltage

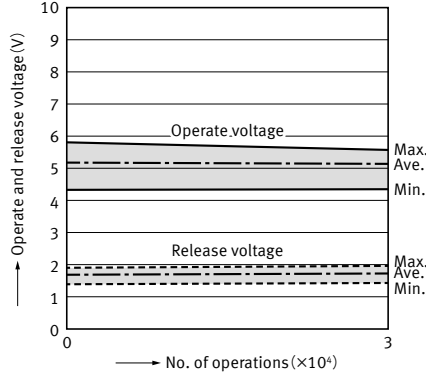

Change of contact resistance

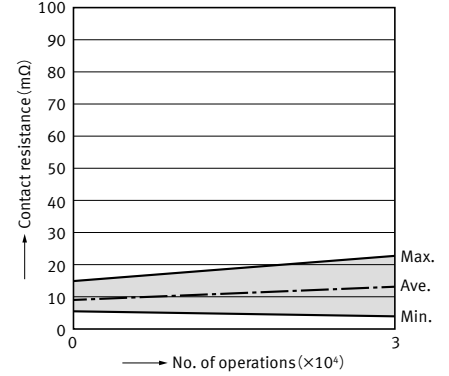

2. Coil temperature characteristics (Average)

Tested sample : ALFG1PF09, ALFG1PF091, 6 pcs.
 Measured portion : Coil inside
 Contact current : 22A
 Ambient temperature : 20°C, 60°C

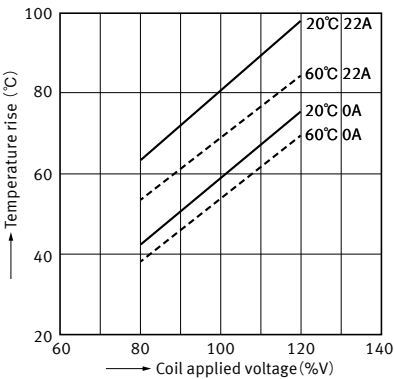

3. Ambient temperature characteristics

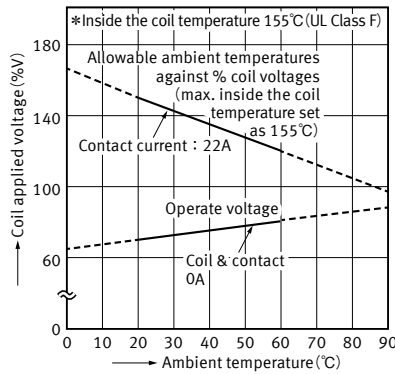

High capacity type

● Contact GAP 1.5 mm

1. Electrical life test (31 A 250 V AC $\cos\phi = 0.8$ Inductive load)

Tested sample : ALFG2PF09, 6 pcs.
 Operation frequency : ON : OFF = 0.1s : 10s
 Ambient temperature : 85°C

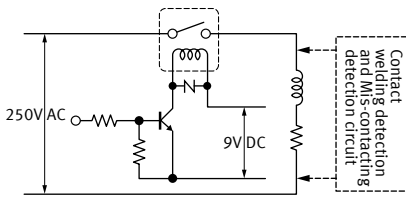

Change of operate and release voltage

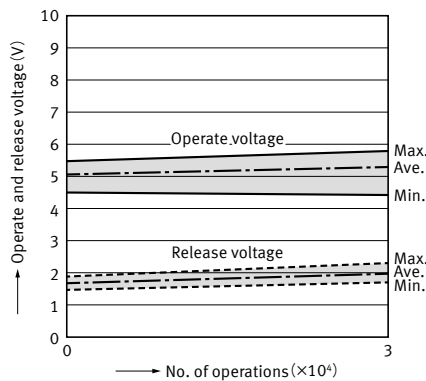

Change of contact resistance

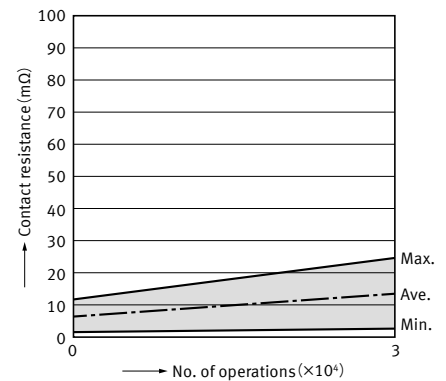

2. Coil temperature characteristics (Average)

Tested sample : ALFG2PF09, 6 pcs.
 Measured portion : Coil inside
 Contact current : 31A
 Ambient temperature : 20°C, 60°C

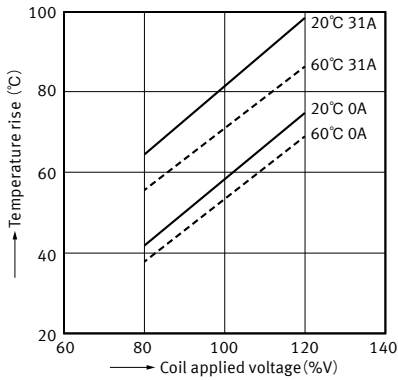

3. Ambient temperature characteristics

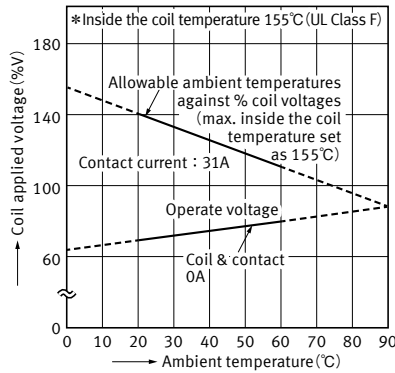

● Contact GAP 1.8 mm

1. Electrical life test (33 A 250 V AC $\cos\phi = 0.8$ Inductive load)

Tested sample : ALFG2PF091, 6 pcs.
 Operation frequency : ON : OFF = 0.1s : 10s
 Ambient temperature : 85°C
 Circuit :

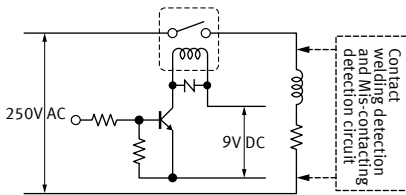

Change of operate and release voltage

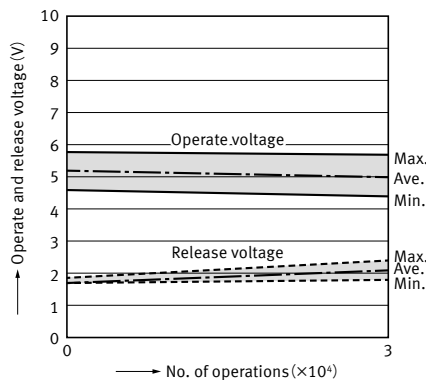

Change of contact resistance

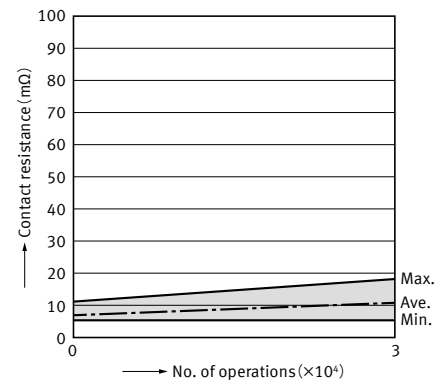

Power relays (Over 2 A) LF-G RELAYS

2. Coil temperature characteristics

(Average)

Tested sample : ALFG2PF091, 6 pcs.
 Measured portion : Coil inside
 Contact current : 33A
 Ambient temperature : 20°C, 60°C

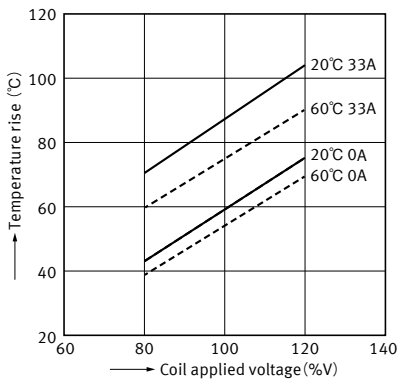

3. Ambient temperature characteristics

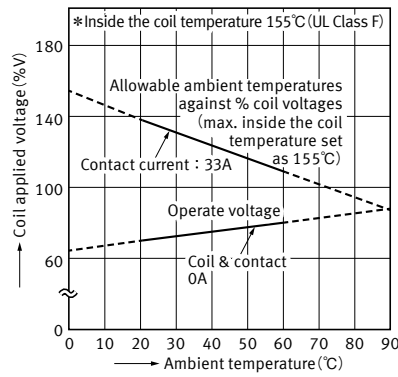

DIMENSIONS

CAD The CAD data of the products with a "CAD" mark can be downloaded from our Website.

Unit: mm

CAD



External dimensions

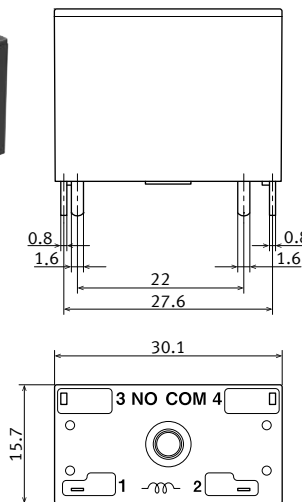

Recommended PC board pattern (BOTTOM VIEW)

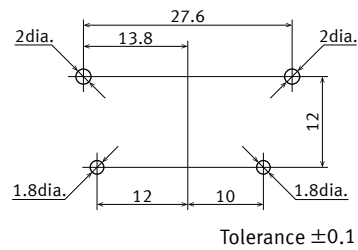

Schematic (BOTTOM VIEW)

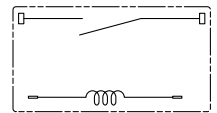

General tolerance
 Less than 1mm : ± 0.1
 Min. 1mm less than 3mm : ± 0.2
 Min. 3mm : ± 0.3

SAFETY STANDARDS

Each standard may be updated at any time, so please check our Website for the latest information.

UL/C-UL (Recognized)

● Standard type

File No.	Contact rating	Operations	Ambient temperature
E43028	22 A 277 V AC General use	30 × 10 ³	85°C
	22 A 30 V DC Resistive	30 × 10 ³	40°C

● High capacity type

Contact GAP 1.5 mm

File No.	Contact rating	Operations	Ambient temperature
E43028	31 A 277 V AC General use	30 × 10 ³	85°C

Contact GAP1.8 mm

File No.	Contact rating	Operations	Ambient temperature
E43028	33 A 277 V AC General use	30 × 10 ³	85°C

CSA (Certified)

CSA standard certified by C-UL

VDE (Certified)

● Standard type

File No.	Contact rating	Operations	Ambient temperature
40023067	22 A 250 V AC (cosφ = 0.8)	30 × 10 ³	85°C

● High capacity type

Contact GAP 1.5 mm

File No.	Contact rating	Operations	Ambient temperature
40023067	31 A 250 V AC (cosφ = 0.8)	30 × 10 ³	85°C

Contact GAP1.8 mm

File No.	Contact rating	Operations	Ambient temperature
40023067	33 A 250 V AC (cosφ = 0.8)	30 × 10 ³	85°C

INSULATION CHARACTERISTICS (IEC61810-1)

Item	Characteristics
Clearance/Creepage distance (IEC61810-1)	Min. 5.5/5.5 mm
Category of protection (IEC61810-1)	RT II
Tracking resistance (IEC60112)	PTI 175
Insulation material group	III a
Over voltage category	III
Rated voltage	250 V
Pollution degree	2
Type of insulation (Between contact and coil)	Reinforced insulation
Type of insulation (Between open contacts)	Full disconnection

Note: Actual value

GUIDELINES FOR USAGE

■ For cautions for use, please read “GUIDELINES FOR RELAY USAGE”.
https://industrial.panasonic.com/ac/e/control/relay/cautions_use/index.jsp

■ Cautions for usage of LF-G relays

● Usage, transport and storage conditions

1) Temperature

- 40 to +60°C (When rated coil voltage applied)
- 40 to +85°C (When coil holding voltage is 45 to 80% V of rated coil voltage)

2) Humidity

5 to 85% RH (Avoid icing and condensation)

Note: The humidity range varies with the temperature. Use within the range indicated in the graph.

3) Atmospheric pressure

86 to 106 kPa

[Temperature and humidity range for usage, transport, and storage]

[When rated coil voltage applied]

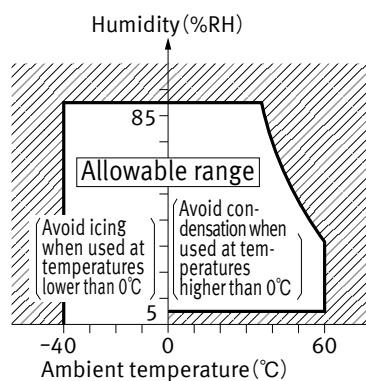

[When coil holding voltage is 45 to 80% V of rated coil voltage]

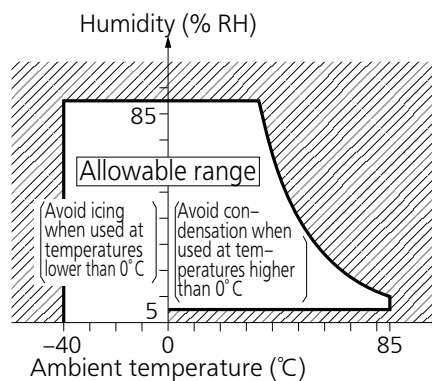

GUIDELINES FOR POWER, HIGH-CAPACITY DC CUT OFF AND SAFETY RELAYS USAGE

■ For cautions for use, please read “GUIDELINES FOR RELAY USAGE”.
https://industrial.panasonic.com/ac/e/control/relay/cautions_use/index.jsp

Precautions for Coil Input

■ Long term current carrying

A circuit that will be carrying a current continuously for long periods without relay switching operation. (circuits for emergency lamps, alarm devices and error inspection that, for example, revert only during malfunction and output warnings with form B contacts)
Continuous, long-term current to the coil will facilitate deterioration of coil insulation and characteristics due to heating of the coil itself. For circuits such as these, please use a magnetic-hold type latching relay. If you need to use a single stable relay, use a sealed type relay that is not easily affected by ambient conditions and make a failsafe circuit design that considers the possibility of contact failure or disconnection.

■ DC Coil operating power

Steady state DC current should be applied to the coil. The wave form should be rectangular. If it includes ripple, the ripple factor should be less than 5%.

However, please check with the actual circuit since the electrical characteristics may vary. The rated coil voltage should be applied to the coil and the set/reset pulse time of latching type relay differs for each relays, please refer to the relay's individual specifications.

■ Coil connection

When connecting coils of polarized relays, please check coil polarity (+,-) at the internal connection diagram (Schematic). If any wrong connection is made, it may cause unexpected malfunction, like abnormal heat, fire and so on, and circuit do not work. Avoid impressing voltages to the set coil and reset coil at the same time.

■ Maximum allowable voltage and temperature rise

Proper usage requires that the rated coil voltage be impressed on the coil. Note, however, that if a voltage greater than or equal to the maximum continuous voltage is impressed on the coil, the coil may burn or its layers short due to the temperature rise. Furthermore, do not exceed the usable ambient temperature range listed in the catalog.

■ Operate voltage change due to coil temperature rise

In DC relays, after continuous passage of current in the coil, if the current is turned OFF, then immediately turned ON again, due to the temperature rise in the coil, the operate voltage will become somewhat higher. Also, it will be the same as using it in a higher temperature atmosphere. The resistance/temperature relationship for copper wire is about 0.4% for 1°C, and with this ratio the coil resistance increases. That is, in order to operate of the relay, it is necessary that the voltage be higher than the operate voltage and the operate voltage rises in accordance with the increase in the resistance value. However, for some polarized relays, this rate of change is considerably smaller.

Ambient Environment

■ Usage, Transport, and Storage Conditions

During usage, storage, or transportation, avoid locations subjected to direct sunlight and maintain normal temperature, humidity and pressure conditions.

● Temperature/Humidity/Pressure

When transporting or storing relays while they are tube packaged, there are cases the temperature may differ from the allowable range. In this case be sure to check the individual specifications. Also allowable humidity level is influenced by temperature, please check charts shown below and use relays within mentioned conditions. (Allowable temperature values differ for each relays, please refer to the relay's individual specifications.)

1) Temperature:

The tolerance temperature range differs for each relays, please refer to the relay's individual specifications

2) Humidity: 5 to 85 % RH

3) Pressure: 86 to 106 kPa

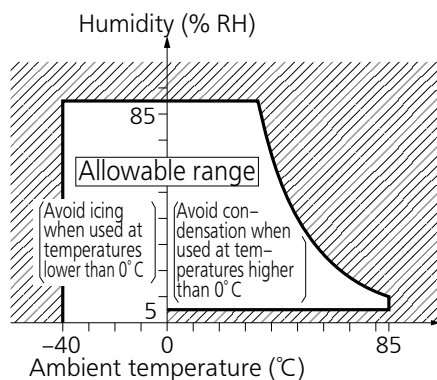

● Dew condensation

Condensation occurs when the ambient temperature drops suddenly from a high temperature and humidity, or the relay is suddenly transferred from a low ambient temperature to a high temperature and humidity. Condensation causes the failures like insulation deterioration, wire disconnection and rust etc.

Panasonic Industry Co., Ltd. does not guarantee the failures caused by condensation.

The heat conduction by the equipment may accelerate the cooling of device itself, and the condensation may occur.

Please conduct product evaluations in the worst condition of the actual usage. (Special attention should be paid when high temperature heating parts are close to the device. Also please consider the condensation may occur inside of the device.)

● Icing

Condensation or other moisture may freeze on relays when the temperature become lower than 0°C. This icing causes the sticking of movable portion, the operation delay and the contact conduction failure etc. Panasonic Industry Co., Ltd. does not guarantee the failures caused by the icing.

The heat conduction by the equipment may accelerate the cooling of relay itself and the icing may occur. Please conduct product evaluations in the worst condition of the actual usage.

● Low temperature and low humidity

The plastic becomes brittle if the switch is exposed to a low temperature, low humidity environment for long periods of time.

● High temperature and high humidity

Storage for extended periods of time (including transportation periods) at high temperature or high humidity levels or in atmospheres with organic gases or sulfide gases may cause a sulfide film or oxide film to form on the surfaces of the contacts and/or it may interfere with the functions. Check out the atmosphere in which the units are to be stored and transported.

● Package

In terms of the packing format used, make every effort to keep the effects of moisture, organic gases and sulfide gases to the absolute minimum.

● Silicon

When a source of silicone substances (silicone rubber, silicone oil, silicone coating materials and silicone filling materials etc.) is used around the relay, the silicone gas (low molecular siloxane etc.) may be produced.

This silicone gas may penetrate into the inside of the relay. When the relay is kept and used in this condition, silicone compound may adhere to the relay contacts which may cause the contact failure.

Do not use any sources of silicone gas around the relay (Including plastic seal types).

● NOx Generation

When relay is used in an atmosphere high in humidity to switch a load which easily produces an arc, the NOx created by the arc and the water absorbed from outside the relay combine to produce nitric acid.

This corrodes the internal metal parts and adversely affects operation.

Avoid use at an ambient humidity of 85%RH or higher (at 20°C). If use at high humidity is unavoidable, please contact our sales representative.

Others

■ Cleaning

• Although the environmentally sealed type relay (plastic sealed type, etc.) can be cleaned, avoid immersing the relay into cold liquid (such as cleaning solvent) immediately after soldering. Doing so may deteriorate the sealing performance.

• Cleaning with the boiling method is recommended(The temperature of cleaning liquid should be 40°C or lower).

Avoid ultrasonic cleaning on relays. Use of ultrasonic cleaning may cause breaks in the coil or slight sticking of the contacts due to ultrasonic energy.

Please refer to **"the latest product specifications"** when designing your product.

•Requests to customers:

<https://industrial.panasonic.com/ac/e/salespolicies/>

Panasonic
INDUSTRY

Panasonic Industry Co., Ltd.

Electromechanical Control Business Division
■1006, Oaza Kadoma, Kadoma-shi, Osaka 571-8506, Japan
industrial.panasonic.com/ac/e/