

Zener Voltage Regulators

225 mW SOT-23 Surface Mount

MMBZ52xxBLT1G Series, SZMMBZ52xxBLT1G Series

This series of Zener diodes is offered in the convenient, surface mount plastic SOT-23 package. These devices are designed to provide voltage regulation with minimum space requirement. They are well suited for applications such as cellular phones, hand held portables, and high density PC boards.

Features

- 225 mW Rating on FR-4 or FR-5 Board
- Zener Voltage Range – 2.4 V to 91 V
- Package Designed for Optimal Automated Board Assembly
- Small Package Size for High Density Applications
- ESD Rating of Class 3 (> 16 KV) per Human Body Model
- SZ Prefix for Automotive and Other Applications Requiring Unique Site and Control Change Requirements; AEC-Q101 Qualified and PPAP Capable
- These Devices are Pb-Free, Halogen Free/BFR Free and are RoHS Compliant

Mechanical Characteristics

CASE: Void-free, transfer-molded, thermosetting plastic case

FINISH: Corrosion resistant finish, easily solderable

MAXIMUM CASE TEMPERATURE FOR SOLDERING PURPOSES:

260°C for 10 Seconds

POLARITY: Cathode indicated by polarity band

FLAMMABILITY RATING: UL 94 V-0

MAXIMUM RATINGS

Rating	Symbol	Max	Units
Total Power Dissipation on FR-5 Board, (Note 1) @ $T_A = 25^\circ\text{C}$ Derated above 25°C	P_D	225 1.8	mW mW/ $^\circ\text{C}$
Thermal Resistance, Junction-to-Ambient (Note 1)	$R_{\theta JA}$	556	$^\circ\text{C}/\text{W}$
Total Power Dissipation on Alumina Substrate, (Note 2) @ $T_A = 25^\circ\text{C}$ Derated above 25°C	P_D	300 2.4	mW mW/ $^\circ\text{C}$
Thermal Resistance, Junction-to-Ambient (Note 2)	$R_{\theta JA}$	417	$^\circ\text{C}/\text{W}$
Junction and Storage Temperature Range	T_J, T_{stg}	-65 to +150	$^\circ\text{C}$

Stresses exceeding those listed in the Maximum Ratings table may damage the device. If any of these limits are exceeded, device functionality should not be assumed, damage may occur and reliability may be affected.

1. FR-5 = 1.0 X 0.75 X 0.62 in.
2. Alumina = 0.4 X 0.3 X 0.024 in, 99.5% alumina.



ON Semiconductor®

www.onsemi.com

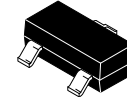

SOT-23
CASE 318
STYLE 8

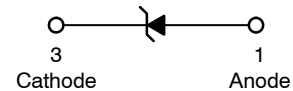

MARKING DIAGRAM

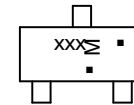

- xxx = Specific Device Code
- M = Date Code
- = Pb-Free Package

(Note: Microdot may be in either location)

ORDERING INFORMATION

Device	Package	Shipping†
MMBZ52xxBLT1G	SOT-23 (Pb-Free)	3,000 / Tape & Reel
SZMMBZ52xxBLT1G	SOT-23 (Pb-Free)	3,000 / Tape & Reel
MMBZ52xxBLT3G	SOT-23 (Pb-Free)	10,000 / Tape & Reel
SZMMBZ52xxBLT3G	SOT-23 (Pb-Free)	10,000 / Tape & Reel

†For information on tape and reel specifications, including part orientation and tape sizes, please refer to our Tape and Reel Packaging Specifications Brochure, BRD8011/D.

DEVICE MARKING INFORMATION

See specific marking information in the device marking column of the Electrical Characteristics table on page 3 of this data sheet.

MMBZ52xxBLT1G Series, SZMMBZ52xxBLT1G Series

ELECTRICAL CHARACTERISTICS

(Pinout: 1-Anode, 2-No Connection, 3-Cathode) ($T_A = 25^\circ\text{C}$ unless otherwise noted, $V_F = 0.95\text{ V Max. @ } I_F = 10\text{ mA}$)

Symbol	Parameter
V_Z	Reverse Zener Voltage @ I_{ZT}
I_{ZT}	Reverse Current
Z_{ZT}	Maximum Zener Impedance @ I_{ZT}
I_{ZK}	Reverse Current
Z_{ZK}	Maximum Zener Impedance @ I_{ZK}
I_R	Reverse Leakage Current @ V_R
V_R	Reverse Voltage
I_F	Forward Current
V_F	Forward Voltage @ I_F

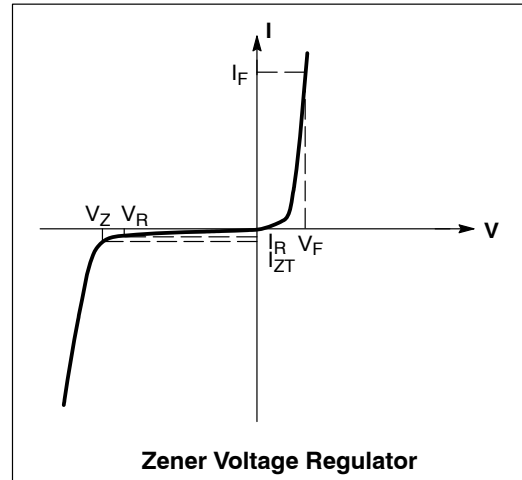

MMBZ52xxBLT1G Series, SZMMBZ52xxBLT1G Series

ELECTRICAL CHARACTERISTICS (Pinout: 1-Anode, 2-NC, 3-Cathode) ($V_F = 0.9\text{ V Max @ }I_F = 10\text{ mA}$ for all types.)

Device*	Device Marking	Zener Voltage (Note 3)			Zener Impedance			Leakage Current		
		V _Z (Volts)			@ I _{ZT}	Z _{ZT} @ I _{ZT}	Z _{ZK} @ I _{ZK}		I _R @ V _R	
		Min	Nom	Max	mA	Ω	Ω	mA	μA	Volts
MMBZ5221BLT1G	18A	2.28	2.4	2.52	20	30	1200	0.25	100	1
MMBZ5222BLT1G	18B	2.37	2.5	2.63	20	30	1250	0.25	100	1
MMBZ5223BLT1G	18C	2.56	2.7	2.84	20	30	1300	0.25	75	1
MMBZ5224BLT1G	18D	2.66	2.8	2.94	20	30	1400	0.25	75	1
MMBZ5225BLT1G	18E	2.85	3	3.15	20	29	1600	0.25	50	1
MMBZ5226BLT1G	8A	3.13	3.3	3.47	20	28	1600	0.25	25	1
MMBZ5227BLT1G	8B	3.42	3.6	3.78	20	24	1700	0.25	15	1
MMBZ5228BLT1G	8C	3.70	3.9	4.10	20	23	1900	0.25	10	1
MMBZ5229BLT1G	8D	4.08	4.3	4.52	20	22	2000	0.25	5	1
MMBZ5230BLT1G	8E	4.46	4.7	4.94	20	19	1900	0.25	5	2
MMBZ5231BLT1G/T3G	8F	4.84	5.1	5.36	20	17	1600	0.25	5	2
MMBZ5232BLT1G/T3G	8G	5.32	5.6	5.88	20	11	1600	0.25	5	3
MMBZ5233BLT1G	8H	5.70	6	6.30	20	7	1600	0.25	5	3.5
MMBZ5234BLT1G/T3G	8J	5.89	6.2	6.51	20	7	1000	0.25	5	4
MMBZ5235BLT1G	8K	6.46	6.8	7.14	20	5	750	0.25	3	5
MMBZ5236BLT1G	8L	7.12	7.5	7.88	20	6	500	0.25	3	6
MMBZ5237BLT1G	8M	7.79	8.2	8.61	20	8	500	0.25	3	6.5
MMBZ5238BLT1G	8N	8.26	8.7	9.14	20	8	600	0.25	3	6.5
MMBZ5239BLT1G	8P	8.64	9.1	9.56	20	10	600	0.25	3	7
MMBZ5240BLT1G	8Q	9.50	10	10.50	20	17	600	0.25	3	8
MMBZ5241BLT1G/T3G	8R	10.4	11	11.55	20	22	600	0.25	2	8.4
MMBZ5242BLT1G/T3G	8S	11.40	12	12.60	20	30	600	0.25	1	9.1
MMBZ5243BLT1G	8T	12.35	13	13.65	9.5	13	600	0.25	0.5	9.9
MMBZ5244BLT1G	8U	13.30	14	14.70	9	15	600	0.25	0.1	10
MMBZ5245BLT1G	8V	14.25	15	15.75	8.5	16	600	0.25	0.1	11
MMBZ5246BLT1G	8W	15.20	16	16.80	7.8	17	600	0.25	0.1	12
MMBZ5247BLT1G/T3G	8X	16.15	17	17.85	7.4	19	600	0.25	0.1	13
MMBZ5248BLT1G/T3G	8Y	17.10	18	18.90	7	21	600	0.25	0.1	14
MMBZ5249BLT1G	8Z	18.05	19	19.95	6.6	23	600	0.25	0.1	14
MMBZ5250BLT1G/T3G	81A	19.00	20	21.00	6.2	25	600	0.25	0.1	15
MMBZ5251BLT1G	81B	20.90	22	23.10	5.6	29	600	0.25	0.1	17
MMBZ5252BLT1G	81C	22.80	24	25.20	5.2	33	600	0.25	0.1	18
MMBZ5253BLT1G	81D	23.75	25	26.25	5	35	600	0.25	0.1	19
MMBZ5254BLT1G	81E	25.65	27	28.35	4.6	41	600	0.25	0.1	21
MMBZ5255BLT1G	81F	26.60	28	29.40	4.5	44	600	0.25	0.1	21
MMBZ5256BLT1G	81G	28.50	30	31.50	4.2	49	600	0.25	0.1	23
MMBZ5257BLT1G/T3G	81H	31.35	33	34.65	3.8	58	700	0.25	0.1	25
MMBZ5258BLT1G	81J	34.20	36	37.80	3.4	70	700	0.25	0.1	27
MMBZ5259BLT1G	81K	37.05	39	40.95	3.2	80	800	0.25	0.1	30
MMBZ5260BLT1G	81L	40.85	43	45.15	3	93	900	0.25	0.1	33
MMBZ5261BLT1G/T3G	81M	44.65	47	49.35	2.7	105	1000	0.25	0.1	36
MMBZ5262BLT1G	81N	48.45	51	53.55	2.5	125	1100	0.25	0.1	39
MMBZ5263BLT1G	81P	53.20	56	58.80	2.2	150	1300	0.25	0.1	43
MMBZ5264BLT1G	81Q	57.00	60	63.00	2.1	170	1400	0.25	0.1	46
MMBZ5265BLT1G	81R	58.90	62	65.10	2	185	1400	0.25	0.1	47
MMBZ5266BLT1G	81S	64.60	68	71.40	1.8	230	1600	0.25	0.1	52
MMBZ5267BLT1G	81T	71.25	75	78.75	1.7	270	1700	0.25	0.1	56
MMBZ5268BLT1G	81U	77.90	82	86.10	1.5	330	2000	0.25	0.1	62
MMBZ5270BLT1G	81W	86.45	91	95.55	1.4	400	2300	0.25	0.1	69

Product parametric performance is indicated in the Electrical Characteristics for the listed test conditions, unless otherwise noted. Product performance may not be indicated by the Electrical Characteristics if operated under different conditions.

3. Zener voltage is measured with a pulse test current I_Z at an ambient temperature of 25°C

NOTE: MMBZ5233BLT1G, MMBZ5246BLT1G, MMBZ5251BLT1G, and MMBZ5252BLT1G Not Available in 10,000/Tape & Reel.

*Include SZ-prefix devices where applicable.

MMBZ52xxBLT1G Series, SZMMBZ52xxBLT1G Series

TYPICAL CHARACTERISTICS

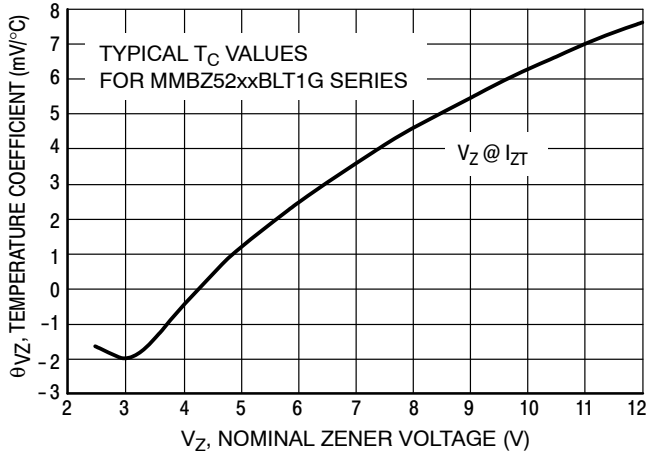

**Figure 1. Temperature Coefficients
(Temperature Range -55°C to +150°C)**

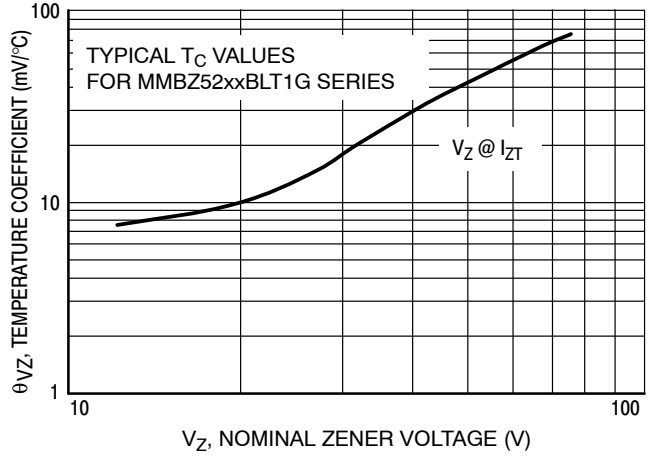

**Figure 2. Temperature Coefficients
(Temperature Range -55°C to +150°C)**

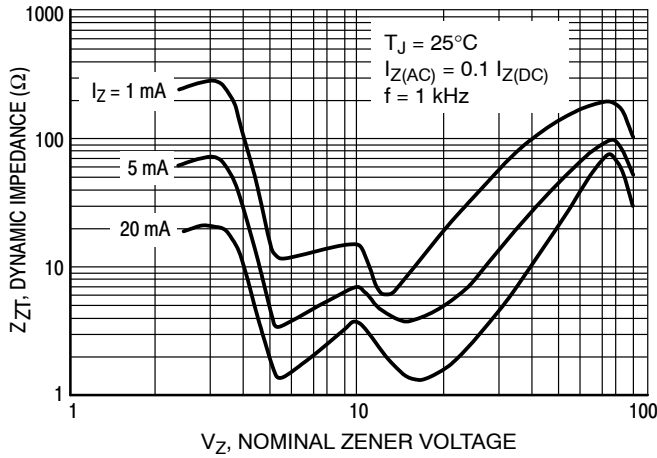

**Figure 3. Effect of Zener Voltage on
Zener Impedance**

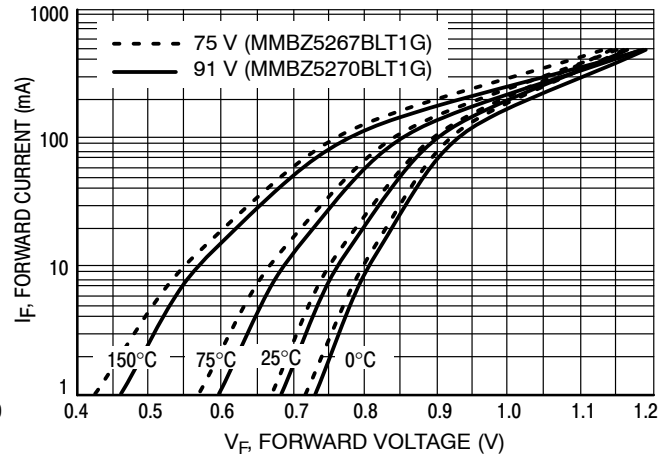

Figure 4. Typical Forward Voltage

MMBZ52xxBLT1G Series, SZMMBZ52xxBLT1G Series

TYPICAL CHARACTERISTICS

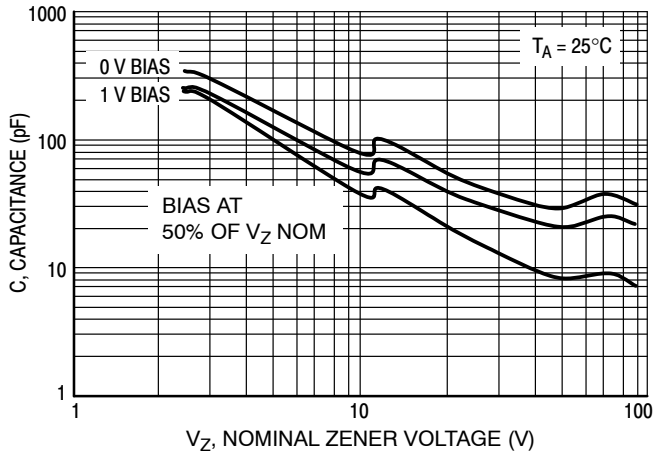

Figure 5. Typical Capacitance

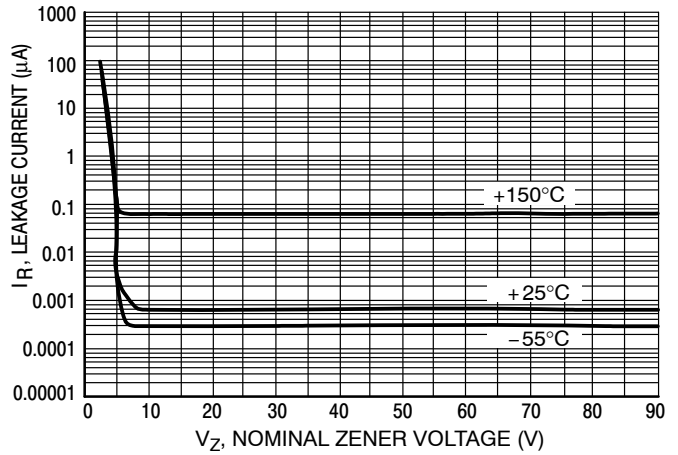

Figure 6. Typical Leakage Current

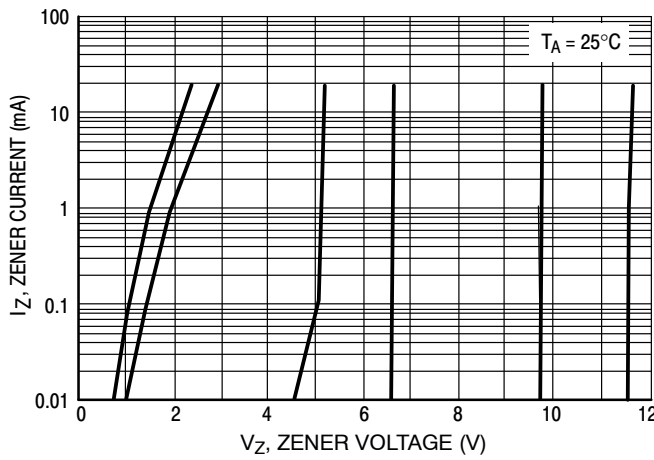

Figure 7. Zener Voltage versus Zener Current (V_Z Up to 12 V)

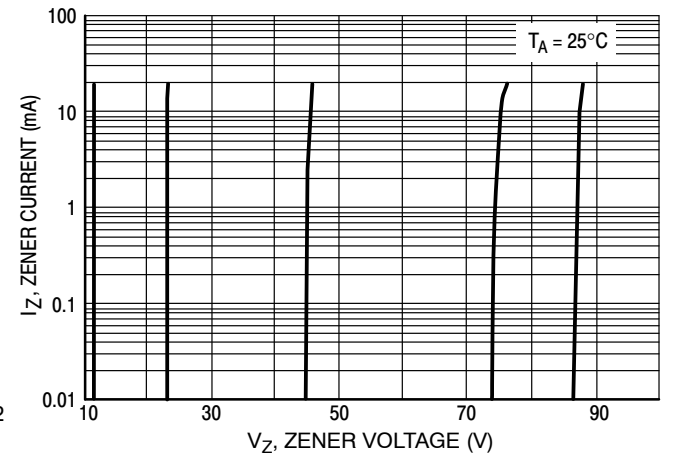
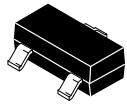

Figure 8. Zener Voltage versus Zener Current (12 V to 91 V)

MECHANICAL CASE OUTLINE

PACKAGE DIMENSIONS

ON Semiconductor®



SOT-23 (TO-236) CASE 318-08 ISSUE AS

DATE 30 JAN 2018

SCALE 4:1

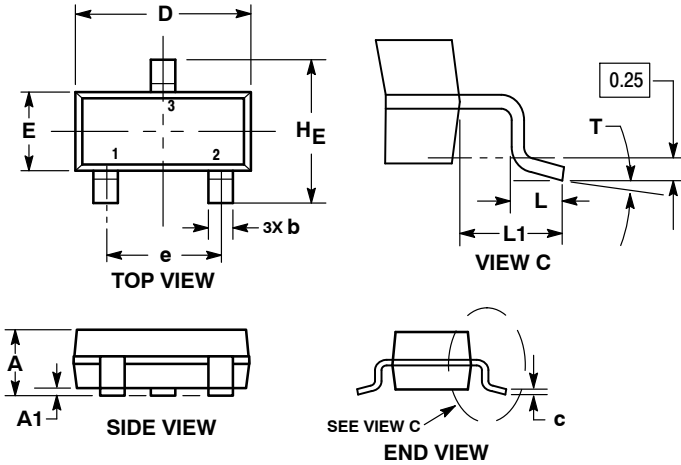

NOTES:

1. DIMENSIONING AND TOLERANCING PER ASME Y14.5M, 1994.
2. CONTROLLING DIMENSION: MILLIMETERS.
3. MAXIMUM LEAD THICKNESS INCLUDES LEAD FINISH. MINIMUM LEAD THICKNESS IS THE MINIMUM THICKNESS OF THE BASE MATERIAL.
4. DIMENSIONS D AND E DO NOT INCLUDE MOLD FLASH, PROTRUSIONS, OR GATE BURRS.

DIM	MILLIMETERS			INCHES		
	MIN	NOM	MAX	MIN	NOM	MAX
A	0.89	1.00	1.11	0.035	0.039	0.044
A1	0.01	0.06	0.10	0.000	0.002	0.004
b	0.37	0.44	0.50	0.015	0.017	0.020
c	0.08	0.14	0.20	0.003	0.006	0.008
D	2.80	2.90	3.04	0.110	0.114	0.120
E	1.20	1.30	1.40	0.047	0.051	0.055
e	1.78	1.90	2.04	0.070	0.075	0.080
L	0.30	0.43	0.55	0.012	0.017	0.022
L1	0.35	0.54	0.69	0.014	0.021	0.027
HE	2.10	2.40	2.64	0.083	0.094	0.104
T	0°	---	10°	0°	---	10°

RECOMMENDED SOLDERING FOOTPRINT

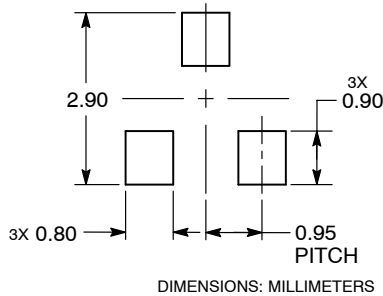

GENERIC MARKING DIAGRAM*

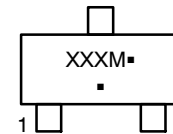

XXX = Specific Device Code
M = Date Code
▪ = Pb-Free Package

*This information is generic. Please refer to device data sheet for actual part marking. Pb-Free indicator, "G" or microdot "▪", may or may not be present.

STYLE 1 THRU 5:
CANCELLED

STYLE 6:
PIN 1. BASE
2. EMITTER
3. COLLECTOR

STYLE 7:
PIN 1. EMITTER
2. BASE
3. COLLECTOR

STYLE 8:
PIN 1. ANODE
2. NO CONNECTION
3. CATHODE

STYLE 9:
PIN 1. ANODE
2. ANODE
3. CATHODE

STYLE 10:
PIN 1. DRAIN
2. SOURCE
3. GATE

STYLE 11:
PIN 1. ANODE
2. CATHODE
3. CATHODE-ANODE

STYLE 12:
PIN 1. CATHODE
2. CATHODE
3. ANODE

STYLE 13:
PIN 1. SOURCE
2. DRAIN
3. GATE

STYLE 14:
PIN 1. CATHODE
2. GATE
3. ANODE

STYLE 15:
PIN 1. GATE
2. CATHODE
3. ANODE

STYLE 16:
PIN 1. ANODE
2. CATHODE
3. CATHODE

STYLE 17:
PIN 1. NO CONNECTION
2. ANODE
3. CATHODE

STYLE 18:
PIN 1. NO CONNECTION
2. CATHODE
3. ANODE

STYLE 19:
PIN 1. CATHODE
2. ANODE
3. CATHODE-ANODE

STYLE 20:
PIN 1. CATHODE
2. ANODE
3. GATE

STYLE 21:
PIN 1. GATE
2. SOURCE
3. DRAIN

STYLE 22:
PIN 1. RETURN
2. OUTPUT
3. INPUT

STYLE 23:
PIN 1. ANODE
2. ANODE
3. CATHODE

STYLE 24:
PIN 1. GATE
2. DRAIN
3. SOURCE

STYLE 25:
PIN 1. ANODE
2. CATHODE
3. GATE

STYLE 26:
PIN 1. CATHODE
2. ANODE
3. NO CONNECTION

STYLE 27:
PIN 1. CATHODE
2. CATHODE
3. CATHODE

STYLE 28:
PIN 1. ANODE
2. ANODE
3. ANODE

DOCUMENT NUMBER:	98ASB42226B	Electronic versions are uncontrolled except when accessed directly from the Document Repository. Printed versions are uncontrolled except when stamped "CONTROLLED COPY" in red.
DESCRIPTION:	SOT-23 (TO-236)	PAGE 1 OF 1

ON Semiconductor and ON are trademarks of Semiconductor Components Industries, LLC dba ON Semiconductor or its subsidiaries in the United States and/or other countries. ON Semiconductor reserves the right to make changes without further notice to any products herein. ON Semiconductor makes no warranty, representation or guarantee regarding the suitability of its products for any particular purpose, nor does ON Semiconductor assume any liability arising out of the application or use of any product or circuit, and specifically disclaims any and all liability, including without limitation special, consequential or incidental damages. ON Semiconductor does not convey any license under its patent rights nor the rights of others.

ON Semiconductor and  are trademarks of Semiconductor Components Industries, LLC dba ON Semiconductor or its subsidiaries in the United States and/or other countries. ON Semiconductor owns the rights to a number of patents, trademarks, copyrights, trade secrets, and other intellectual property. A listing of ON Semiconductor's product/patent coverage may be accessed at www.onsemi.com/site/pdf/Patent-Marking.pdf. ON Semiconductor reserves the right to make changes without further notice to any products herein. ON Semiconductor makes no warranty, representation or guarantee regarding the suitability of its products for any particular purpose, nor does ON Semiconductor assume any liability arising out of the application or use of any product or circuit, and specifically disclaims any and all liability, including without limitation special, consequential or incidental damages. Buyer is responsible for its products and applications using ON Semiconductor products, including compliance with all laws, regulations and safety requirements or standards, regardless of any support or applications information provided by ON Semiconductor. "Typical" parameters which may be provided in ON Semiconductor data sheets and/or specifications can and do vary in different applications and actual performance may vary over time. All operating parameters, including "Typicals" must be validated for each customer application by customer's technical experts. ON Semiconductor does not convey any license under its patent rights nor the rights of others. ON Semiconductor products are not designed, intended, or authorized for use as a critical component in life support systems or any FDA Class 3 medical devices or medical devices with a same or similar classification in a foreign jurisdiction or any devices intended for implantation in the human body. Should Buyer purchase or use ON Semiconductor products for any such unintended or unauthorized application, Buyer shall indemnify and hold ON Semiconductor and its officers, employees, subsidiaries, affiliates, and distributors harmless against all claims, costs, damages, and expenses, and reasonable attorney fees arising out of, directly or indirectly, any claim of personal injury or death associated with such unintended or unauthorized use, even if such claim alleges that ON Semiconductor was negligent regarding the design or manufacture of the part. ON Semiconductor is an Equal Opportunity/Affirmative Action Employer. This literature is subject to all applicable copyright laws and is not for resale in any manner.

PUBLICATION ORDERING INFORMATION

LITERATURE FULFILLMENT:

Email Requests to: orderlit@onsemi.com

ON Semiconductor Website: www.onsemi.com

TECHNICAL SUPPORT

North American Technical Support:
Voice Mail: 1 800-282-9855 Toll Free USA/Canada
Phone: 011 421 33 790 2910

Europe, Middle East and Africa Technical Support:

Phone: 00421 33 790 2910

For additional information, please contact your local Sales Representative